

# HIOKI

## EARTH TESTER Series



Ground  
Resistance



## What does “grounding” mean?

Grounding means making an electrical connection between an electrical device or a building and the earth underfoot. Properly grounding equipment and buildings helps ensure safety by preventing electric shock and related accidents. It also helps prevent the occurrence of harmonics, equipment malfunctions, power outages, and other issues with power supply quality. During installation and maintenance, it's critical to make sure the ground resistance values of your grounding equipment conform to the values specified by applicable laws and standards.

## Factors that determine ground resistance

When a current  $I$  [A] flows to a grounding electrode, the grounding electrode's potential  $E$  [V] rises relative to the ground. The resistance  $R$  [ $\Omega$ ], which can be calculated by means of Ohm's law, is known as the ground resistance.

$$R = E / I [\Omega]$$

Ground resistance is determined by factors including geological properties, the shape and configuration of the grounding electrode, the temperature, and the humidity. Of these factors, the impact of geological properties is particularly pronounced, making them important to ascertain. One measurable quantity that can help in understanding the effect of geological properties on ground resistance is soil resistivity. Soil with high resistivity also has high ground resistance. Due to this high effect, soil resistivity must be assessed before determining grounding electrode shape, quantity, and depth.

Factors that determine ground resistance	
Environmental conditions	Geological properties (geological stratum, salt content, etc.), temperature, humidity, etc.
Grounding electrodes	Shape, configuration, quantity, depth

Geological types	Soil resistivity
	$\Omega\text{m}$
Extremely moist soil or marshland	30
Cropland, clayish soil	100
Sandy clay	150
Moist sand	300
Concrete 1:5	400
Moist gravel	500
Dry sand	1,000
Dry gravel	1,000
Calcareous soil	30,000
Bedrock	$10^7$

## Measurement methods

### 3-pole method

Ground resistance

#### Suitable for use in final inspections and maintenance inspections

The 3-pole method is the most common method used to accurately measure ground resistance. In keeping with the definition of ground resistance, the method entails applying a current to the grounding electrode you wish to measure and then calculating the resistance based on the resulting increase in electric potential (voltage). Measurement is performed after verifying that it is safe to disconnect the grounding electrode (for example, while the power has been shut off).

#### Measurement procedure

- (1) Disconnect the grounding electrode you wish to measure from the power supply system.
- (2) Insert the auxiliary grounding electrode S (P) into the ground a distance of 10 m away.
- (3) Insert the auxiliary grounding electrode H (C) into the ground another 10 m away.
- (4) Connect the earth tester's E (C1) terminal, S (P) terminal, and H (C) terminal to the grounding electrode and auxiliary grounding electrodes, respectively.
- (5) Measure the ground resistance.
- (6) Once you've disconnected the earth tester, reconnect the grounding electrode to the power supply system.

#### Efficiency improvement by not having to disconnecting the grounding electrode using the MEC function\* (FT6041 only)

A clamp sensor is used to measure current flowing to the grounding electrode. This approach allows the grounding electrode to be measured while it remains connected to the power supply system.

\*MEC stands for “measuring earth with a clamp.”

#### Accurately measure a few $\Omega$ s or smaller (FT6041 only)

Use the principle of 4-terminal measurement to measure ground resistance. This approach lets you accurately measure low resistance values without being affected by the probes' resistance component.

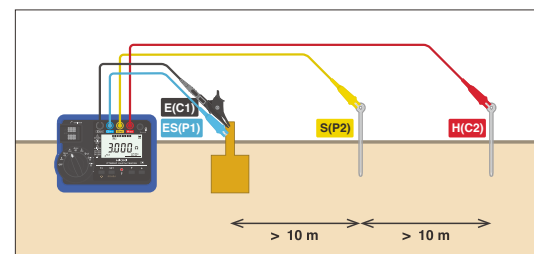
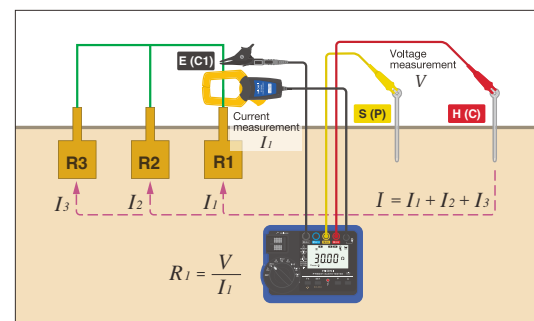
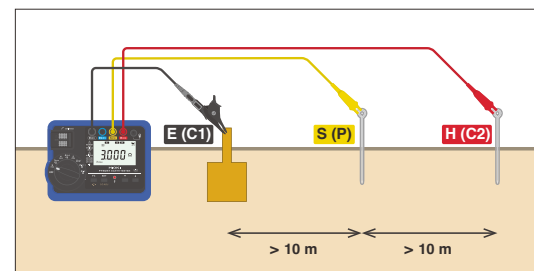



## 2-pole method

Ground resistance

### Suitable for simplified inspections

This method involves measuring the resistance between the grounding electrode you wish to measure and a single auxiliary grounding electrode. The measured resistance value will include the ground resistance of the auxiliary grounding electrode. Consequently, caution is necessary since you won't be able to make an accurate measurement if the auxiliary grounding electrode has a large ground resistance. If you use a grounding electrode that you know to have a low grounding resistance as the auxiliary ground electrode, you can easily measure the desired ground resistance.

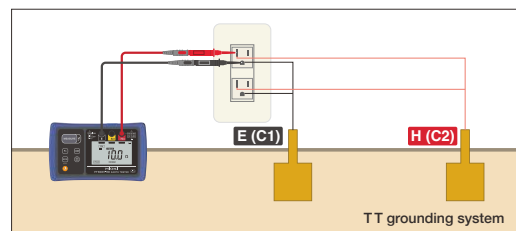

## 2-clamp method

Ground resistance

### Suitable for measuring systems with multiple grounds

Although this method is limited to measuring the ground resistance of systems with multiple grounds, it lets you make measurements simply by attaching two clamp sensors to grounding electrodes. (No auxiliary grounding electrodes are required.)

It's ideal for measuring the ground resistance of multiple grounds, for example at transmission towers, lightning rods, or warehouses.

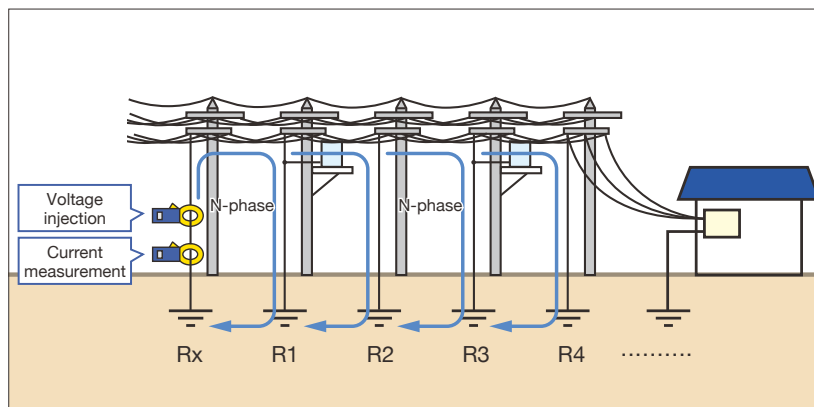

### Measurement principle

Prepare two clamps, one for applying/injecting a voltage and the other for sensing/measuring the current. If you attach the voltage injection clamp to the ground resistance  $R_x$  you wish to measure, current will flow to all multiple grounds. If you measure the current flowing to  $R_x$  with the current measurement sensor, you will have measured the current as in the following equation:

$$R_x + 1/[(1/R1) + (1/R2) + (1/R3) + (1/R4) + \dots] = V/I$$

If there are numerous connections, the value within the square brackets above will be extremely small, with the result that  $R_x \approx V/I$ .

## 4-pole method

Wenner's 4-pole method

Soil resistivity

### For measuring soil resistivity

#### Measurement procedure

- (1) Install four auxiliary grounding electrodes at the fixed interval  $a$  [m].
- (2) Enter the interval  $a$  [m] into the earth tester.
- (3) Perform soil resistivity measurement. It will display the soil resistivity that is calculated using the following equation:

$$\rho = 2\pi aR$$

- (4) In order to find the ideal depth for ground construction, you must make measurements of various depths. Since the distance between auxiliary electrodes equals the depth being measured, you can do this by taking repeated measurements at various intervals  $a$  [m].
- (5) Graph  $a$  and  $\rho$ .

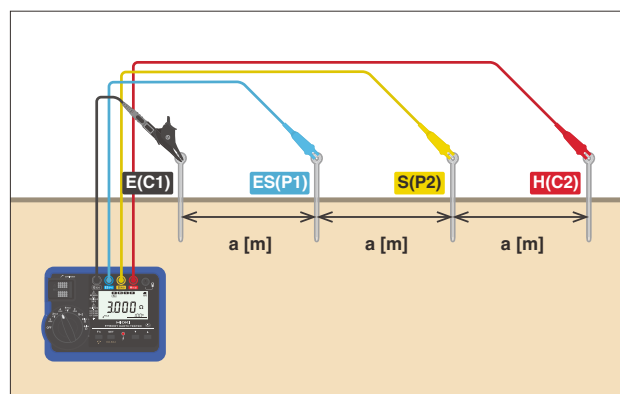

# Choosing an earth tester

This page explains eight key considerations when choosing an earth tester.

## 1 What method will you use to make measurements?

**4-pole method** **3-pole method** **2-pole method** **Clamp method**

The most typical ground resistance measurement method is the 3-pole method, but the clamp measurement method is well suited to measuring ground resistance when there are multiple grounds. Alternately, you'll need an instrument that's capable of 4-pole measurement if you need to measure soil resistivity. Choose an earth tester that can accommodate the measurement method you plan to use.

## 2 How large is the ground resistance you wish to measure?

Measuring ground resistance means accurately measuring resistance values ranging from 1  $\Omega$  to 500  $\Omega$ . The ability to accurately measure low resistance values is particularly important concern since not all devices can do this. Make sure to check the typical resistance range for your measurement target and choose an earth tester that measures that range with the most precision.

## 3 Can the instrument you're considering make stable measurements in a noisy environment?



### Large noise?

When a current flows to the ground from a train, machine tool, or other piece of equipment, a ground potential will result. Ground potential appears as a noise component for earth testers. Instruments with a high allowable ground potential will be able to make stable measurements even when there's a large ground potential.

### Specific frequency noise?

If the measurement current from the earth tester has the same frequency as a noise component, measured values won't stabilize. You can reduce the effects of noise by using an earth tester that can vary the frequency of the measurement current.

## 4 Inserting just doesn't cut it

Importance of "allowable resistance of auxiliary grounding electrode"

Sometimes measurement does not work, no matter how many times you insert the auxiliary electrode, tap it, or add water. This is often due to high resistance when the auxiliary electrode is inserted. (Basically, it can't measure resistance because there is just too much resistance for current to flow for measurement.) There is a spec in earth testers called "allowable resistance of auxiliary grounding electrode" that define the maximum amount of resistance when the auxiliary electrode is inserted. High allowable resistance enables you to measure without inserting the electrode deep into the ground, or by using water and an earth net (see pictures below). Choose the right earth tester with the right "allowable resistance of auxiliary grounding electrode" to reduce frustration and measurement time from repeated measurement and fagging.



It takes time to drive electrodes deep into the ground. Electrodes can't be used at all in some locations.



Make measurements without inserting auxiliary grounding electrodes deep into the ground.



With this earth nets module, simply open and pour water on it, and you can measure on soil or hard surfaces like concrete.

## 5 Long cables causing long testing times?

Measuring ground resistance involves using long measurement cables that are dozens of meters in length. As a result, not only measurement itself, but also set-up and clean-up take time. Check for features that help streamline work, such as reels that let you quickly rewind measurement cables.



## 6 Harsh environments and rugged specs (dust/water resistance, operating temperature/humidity, impact resistance)



Since most work is performed outdoors, you'll need an instrument that can be used for extended periods of time in hot and cold conditions. Be sure to choose an instrument with a broad operating temperature range.



If mud, sand, or other contaminants find their way into the instrument, it could malfunction. When you're working outdoors, there's always a possibility that rainwater will get into the instrument. If the instrument provides IP67 or better dust and water protection, you'll be able to use it with peace of mind.



Physical impacts, for example if the instrument is dropped, can also cause malfunctions. Drop-proof construction will also pay dividends in terms of peace of mind.

## 7 Wireless connectivity Can the instrument record measured values wirelessly?



The instrument will need to record the ground resistance values at all kinds of measurement locations. Connecting the Wireless Adapter Z3210 to a Hioki earth tester adds Bluetooth® connectivity. You can use GENNECT Cross, Hioki's free smartphone app, to easily enter measured values using Bluetooth®.

## 8 Clamp measurement Is it too cramped to clamp?

When measuring ground resistance with a clamp sensor, you'll need to attach the sensors to the grounding electrode. Grounding electrodes may be shaped like a busbar or housed in the confined space of a grounding box, making it impossible to clamp with some sensors. Be sure to check the sensor's shape and size.

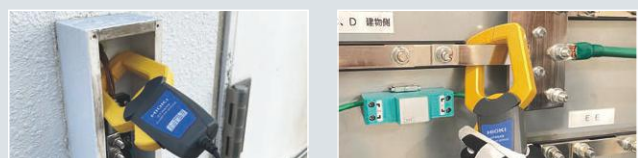

# Comparison chart

Choosing the right instrument for your application will help ensure stable measurement while streamlining your work.

	FT6041	FT6031-50	FT3151	FT6380-50
				
	See p. 6 for details.	See p. 9 for details.	See p. 12 for details.	See p. 10 for details.

Key points from previous page

<b>1</b>	Ground resistance	Two-pole method	✓	✓	✓	-
		Three-pole method	✓	✓	✓	-
		MEC function	✓	-	-	-
		2-clamp method	✓	-	-	✓
	Soil resistivity	Four-pole method	✓	-	-	-
	Ground potential	0 to 30.0 V RMS	0 to 30.0 V RMS	0 to 30.0 V RMS	-	
<b>2</b>	Measurement range (ground resistance)	3 Ω to 300 kΩ	20 Ω to 2000 Ω	10 Ω to 1000 Ω	0.20 Ω to 1600 Ω	
<b>3</b>	Measuring frequency	94, 105, 111, 128, 55 Hz	128 Hz	575, 600 Hz	2375 Hz	
<b>3</b>	Allowable ground potential	30 V RMS (DC or sine wave)	25.0 V RMS (DC or sine wave)	10 V	3 V RMS (DC or sine wave)	
<b>4</b>	Allowable resistance of auxiliary grounding electrode	Max. 100 kΩ	Max. 50 kΩ	Max. 5 kΩ	-	
<b>5</b>	Cord winders	✓	✓	✓	-	
<b>6</b>	Operating temperature	-25°C to 65°C (-13°F to 149°F)	-25°C to 65°C (-13°F to 149°F)	0°C to 40°C (32°F to 104°F)	-10°C to 50°C (14°F to 122°F)	
	Dustproof and waterproof	IP67	IP67	IP40	IP40 with jaws closed	
	Drop-proof	1 m above concrete (with protector attached)	1 m above concrete (with protector attached)	-	-	
<b>7</b>	Support for GENNECT Cross (storage of measured values)	✓	✓	-	✓	
<b>8</b>	Clamp measurement method (maximum measurable conductor diameter)	✓ (with optional sensor)	-	-	✓	
		φ 52 mm (2.05 in.) 78 mm (3.07 in.) × 20 mm (0.79 in.) busbar	-	-	φ 32 mm (1.26 in.)	

## GENNECT Cross (free application)

Compatible models: FT6041, FT6031-50, FT6380-50



WIRELESS ADAPTER Z3210 (option)

### Wireless support Transfer measurements to your phone or tablet

Simply plug in to compatible models to make it Bluetooth® ready. Measurement data can be directly transferred and input to Excel® files.



### Easily transfer measurement data to GENNECT Cross, instantly create reports

Generate reports with site photos and drawings with the free app GENNECT Cross. The software provides a range of functionality that helps manage data in the field, including photographing measurement sites, placing measurement results on photographs, and saving hand written memos.

GENNECT Cross is a free app. The iOS version can be downloaded from the App Store®, while the Android version can be downloaded from Google Play™. Search for “GENNECT Cross” on Google Play™ or the App Store® or scan the QR code below.



# EARTH TESTER NEW FT6041

*Field-capable  
Fast-working*

Extensive measurement functionality



Accuracy guaranteed for 1 year  
Product warranty for 3 years

CE	4-pole method Wenner's 4-pole method	3-pole method	2-pole method	Low-resistance measurement	2-clamp method for multi grounded systems	MEC function	CAT IV 100 V CAT III 150 V CAT II 300 V	Bluetooth® GENNECT Cross (with Z3210)

Extensive measurement functionality: choose the right measurement method for any application

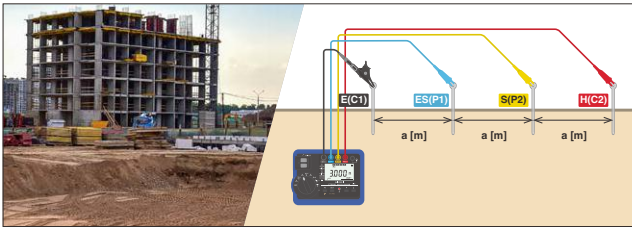

### 4-pole method

#### Measure soil resistivity when surveying a grounding design

Soil resistivity is measured as part of the grounding design process in advance of building design. Soil resistivity varies with each site's geological properties. In this process, optimal ground locations as well as grounding electrode shapes, dimensions, and other characteristics are designed based on the assessed soil resistivity.

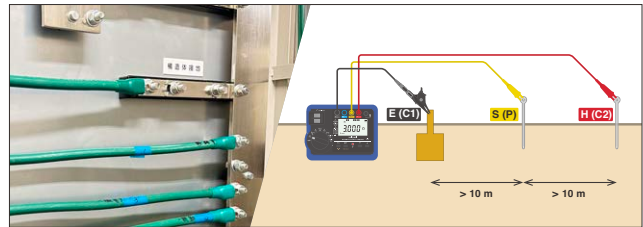

### 3-pole method

#### Precisely measure ground resistance

This type of measurement, which uses auxiliary grounding electrodes, yields accurate ground resistance values. It's ideal for measuring ground resistance in completion testing after construction and in maintenance inspections.

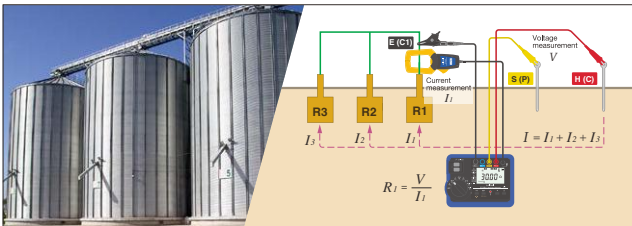

### MEC function

#### Measure ground resistance without disconnecting ground electrodes

This function augments the 3-pole method with current measurement using a clamp sensor. By measuring only current flowing to the grounding electrode you wish to measure, you can avoid the effects of other grounds. This capability can substantially reduce man-hours spent on measurement work.

\*MEC stands for "measuring earth with a clamp."

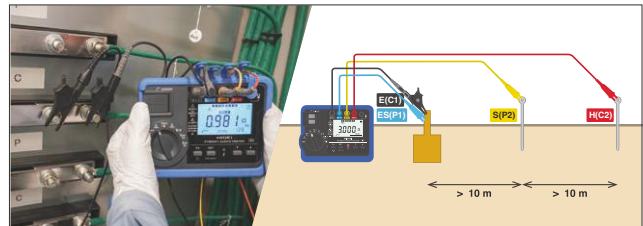

### 3-pole method using 4-terminal measurement

#### Measure ground resistance values of several ohms or less

When measuring extremely low ground resistance, the measurement cords' wiring resistance can affect measurement. By using 4-terminal measurement, which isn't affected by wiring resistance, you can measure ground resistance in a more precise manner.

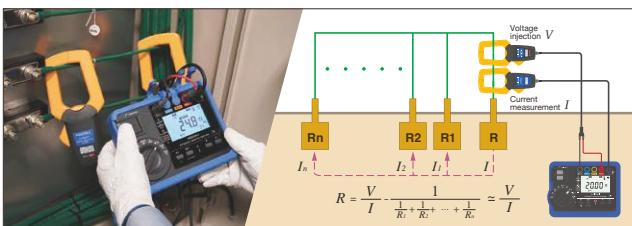

### 2-clamp method

#### Measure grounding resistance at multiple grounds

This method injects a voltage from an injection clamp. A clamp sensor is then used to measure current and with which the ground resistance is calculated. There's no need to insert any auxiliary grounding electrodes into the ground; simply attach these two clamps to the grounding electrode being measured.



### Low-resistance measurement

#### Continuity test after ground resistance measurement

After performing measurement using the 3-pole method, the grounding electrode is reconnected to the power supply system. When doing so, it's necessary to verify continuity by performing low-resistance measurement. Precise confirmation can be accomplished using 4-terminal measurement.

Designed to shorten work times and reduce operator workload



#### Fast measurement!

#### Cord rewinding that doesn't tangle or twist

The combination of fast measurement that displays measured values in just 6 seconds (3-pole method) and easy-to-use cord rewinding shortens work times.



#### Insert just once thanks to 100 kΩ max. allowable resistance

High "allowable resistance of auxiliary grounding electrode" eliminates the inconvenience of needing to insert and reinsert auxiliary electrodes repeatedly in dry soil. The result is shorter work times.



#### Make measurements, even on concrete. Newly designed Earth Nets Module L9846

This module is essentially an auxiliary electrode for flat surfaces in which the traditional stakes can't be inserted. When opened, two copper nets make contact with the surface. Simply make contact and pour water over it to measure ground resistance without inserting any auxiliary electrodes into the ground.

Built tough to withstand use at harsh sites



#### Dirt, sand, and rain resistance IP67 dust and water protection

Since the Earth Tester FT6041 is designed to keep dust and dirt out of its enclosure, you can use it in the field without worrying about mud or dust. If it gets dirty, simply rinse it off with water.

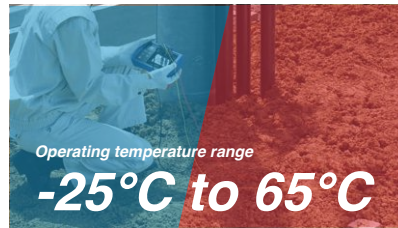

#### Extreme cold, extreme heat. The FT6041 won't fail, even during extended operation.

The instrument, which is designed to be used outdoors for extended periods of time, features a design resilient to extreme temperatures that allows use in a broad temperature range.



#### Withstands being dropped onto concrete from a height of 1 m

Use the FT6041 outdoors with peace of mind thanks to a tough design that's built to withstand being dropped from a height of 1 m during use.

### Basic specifications

Measurement parameters	<ul style="list-style-type: none"> <li>Ground resistance measurement: 4-pole method, 3-pole method, 2-pole method, MEC function, clamp-on measurement (two clamps)</li> <li>Soil resistivity measurement: 4-pole method</li> <li>Low-resistance measurement: 4-terminal method, 2-terminal method</li> <li>Ground potential measurement</li> </ul>
Ground potential	0 to 30.0 V RMS, accuracy: $\pm 2.3\%$ rdg. $\pm 8$ dgt. (50/60 Hz), $\pm 1.3\%$ rdg. $\pm 4$ dgt. (DC)
Functions	Live wire warning, auto power save, soil resistivity display (4-pole method only), zero-adjustment, auto-hold, continuous measurement mode, wireless communication (only when Z3210 is connected), buzzer sound, comparator, switching the display, ground potential overload display (when measuring ground resistance)
Operating temperature and humidity	-25°C to 65°C*1 (non-condensing)
Storage temperature and humidity	-25°C to 65°C: 80% RH or less (non-condensing)
Dustproof and waterproof	IP65/IP67 (EN60529)
Applicable standards	EN 61010 (safety), EN 61326 (EMC), EN61557-1/EN61557-10/EN61557-14 (low-resistance measurement, earth testers), EN61557-5 (earth testers)
Power supply	HR6 nickel-metal hydride battery x 4 or LR03 alkaline battery x 4
Number of measurements per battery charge*2	500 times (3-pole method, without Z3210 installed) 400 times (3-pole method, with Z3210 installed and using wireless communication)
Dimensions and mass	Approx. 189 mm (7.44 in.)W x 148 mm (5.83 in.) H x 48 mm (1.89 in.) D, approx. 765 g (26.98 oz.) (including battery, protector)

Ground resistance measurement: 4-pole method, 3-pole method, 2-pole method						
Measurement principle	Apply voltage and measure voltage and current (measures effective resistance by synchronous detection)					
Ground resistance range	3 $\Omega$ (0 to 3.000 $\Omega$ )	30 $\Omega$ (0 to 30.00 $\Omega$ )	300 $\Omega$ (30.0 $\Omega$ to 300.0 $\Omega$ )	3000 $\Omega$ (300 $\Omega$ to 3000 $\Omega$ )	30.00 k $\Omega$ (3.00 k $\Omega$ to 30.00 k $\Omega$ )	300.0 k $\Omega$ (30.0 k $\Omega$ to 300.0 k $\Omega$ )
Accuracy	$\pm 1.5\%$ rdg. $\pm 6$ dgt.			$\pm 1.5\%$ rdg. $\pm 4$ dgt.		
Allowable resistance of auxiliary grounding electrode	5 k $\Omega$		50 k $\Omega$	100 k $\Omega$		
Allowable ground potential	30 V RMS or 42.4 V peak					
MEC function: 4-pole method with clamp sensor, 3-pole method with clamp sensor						
Measurement principle	Apply voltage and measure voltage and current (measures effective resistance by synchronous detection)					
Ground resistance range	30 $\Omega$ (0.00 to 30.00 $\Omega$ )	300 $\Omega$ (30.0 $\Omega$ to 300.0 $\Omega$ )	3000 $\Omega$ (300 $\Omega$ to 3000 $\Omega$ )	30.00 k $\Omega$ (3 k $\Omega$ to 30.00 k $\Omega$ )		
Accuracy	$\pm 5\%$ rdg. $\pm 6$ dgt.		$\pm 5\%$ rdg. $\pm 3$ dgt.			
Ground resistance measurement: 2-clamp method						
Measurement principle	Apply voltage and measure voltage and current (measures effective resistance by synchronous detection)					
Ground resistance range	20 $\Omega$ (0.02 $\Omega$ to 20.00 $\Omega$ )	200 $\Omega$ (20.0 $\Omega$ to 200.0 $\Omega$ )		500 $\Omega$ (200 $\Omega$ to 500 $\Omega$ )		
Accuracy	$\pm 7\%$ rdg. $\pm 3$ dgt.			$\pm 35\%$ rdg.		
Low-resistance measurement						
Open-circuit voltage	4.0 V to 6.9 V					
Measuring current	200 mA or more					
Measurement range	30 $\Omega$ (0.00 to 30.00 $\Omega$ )	300 $\Omega$ (30.0 $\Omega$ to 300.0 $\Omega$ )		3000 $\Omega$ (300 $\Omega$ to 3000 $\Omega$ )		
Accuracy	$\pm 3$ dgt. (0.00 to 0.19 $\Omega$ ) $\pm 2\%$ rdg. $\pm 2$ dgt. (0.20 $\Omega$ to 10.00 $\Omega$ )		$\pm 2\%$ rdg. $\pm 2$ dgt.			

\*1: -25°C to 40°C, -13°F to 104°F (80% RH or less), 40°C to 45°C, 104°F to 113°F (60% RH or less), 45°C to 50°C, 113°F to 122°F (50% RH or less), 50°C to 55°C, 122°F to 131°F (40% RH or less), 55°C to 60°C, 131°F to 140°F (30% RH or less), 60°C to 65°C, 140°F to 149°F (25% RH or less)

\*2: NiMH battery x 4 (reference value at 23°C)

# EARTH TESTER FT6041

## Included accessories



	Qty.	Note
AUXILIARY EARTHING ROD L9840	2	270 mm (10.63 in.), stainless steel, set of 2
MEASUREMENT CABLE L9845-31	1	Yellow, 25 m (82.02 ft.), equipped with winder
MEASUREMENT CABLE L9845-33	1	Blue, 25 m (82.02 ft.), equipped with winder
MEASUREMENT CABLE L9845-52	1	Red, 50 m (164.04 ft.), equipped with winder
MEASUREMENT CABLE L9841	1	Black alligator clip, 4 m (13.12 ft.) long
TEST LEAD L9787	1	Bundled with line/ground lead, alligator clip, 1.2 m (3.94 ft.) long
EARTH NETS MODULE L9846	2	Use with measuring cord set, built-in grounding/earth nets
CARRYING CASE C0208	1	For storing FT6041 and clamp sensors, hard type
CARRYING CASE C0209	1	For storing measurement cables, soft type
Protector	1	Attaches to and protect FT6041
LR6 Alkaline battery	4	
Instruction manual	1	
Operating precautions	1	



## FT6041-91 set



FT6041 and included accessories, also includes clamps FT9847 and CT9848

Products included in FT6041-91	Qty.	Note
SIGNAL INDUCTION CLAMP FT9847	1	For signal induction, including resistance check loop, $\phi 52$ mm (2.05 in.) or less, 78 mm (3.07 in.) x 20 mm (0.79 in.) bus-bar
OLAMP ON SENSOR CT9848	1	For detection, $\phi 52$ mm (2.05 in.) or less, 78 mm (3.07 in.) x 20 mm (0.79 in.) bus-bar

FT6041 and included accessories



## Options for FT6041 sold separately

To ensure safety, use the separately sold Test Lead L9787 when making measurements using the two-pole method.

SIGNAL INDUCTION CLAMP FT9847 (for signal induction) Including resistance check loop	CLAMP ON SENSOR CT9848 (for detection)	WIRELESS ADAPTER Z3210 Bluetooth® communication will be possible by attaching to the FT6041	AUXILIARY EARTHING ROD L9840 2 piece set, stainless steel	MEASUREMENT CABLE L9841 Alligator clip, black, 4 m (13.12 ft.) long	MEASUREMENT CABLE L9842-11 Yellow 10 m (32.81 ft.) long, equipped with winder	MEASUREMENT CABLE L9842-22 Red 20 m (65.62 ft.) long, equipped with winder
MEASUREMENT CABLE L9845-31 Yellow 25 m (82.02 ft.) long, equipped with winder	MEASUREMENT CABLE L9845-33 Blue 25 m (82.02 ft.) long, equipped with winder	MEASUREMENT CABLE L9845-52 Red 50 m (164.04 ft.) long, equipped with winder	EARTH NETS MODULE L9846	MEASUREMENT CABLE L9843-51 Yellow 50 m (164.04 ft.) long, equipped with flat cable winder	MEASUREMENT CABLE L9843-52 Red 50 m (164.04 ft.) long, equipped with flat cable winder	MEASUREMENT CABLE L9844 For grounding terminal board, red/yellow/black, each 1.2 m (3.94 ft.) long
TEST LEAD L9787 Bundled with line/ground lead, alligator clip, 1.2 m (3.94 ft.) long	PIN TYPE LEAD 9772 For low-resistance measurement by 4-terminal method	LARGE CLIP TYPE LEAD 9467 For low-resistance measurement by 4-terminal method	EARTH NETS 9050 2 sheets in set	CARRYING CASE C0208 For storing FT6041 and clamps, hard type	CARRYING CASE C0209 For storing measurement cables, soft type	FUSE SET Z5052 0.5 A/1000 V Fuse set of 2

# EARTH TESTER

## FT6031-50

**Tough and ready  
for the field**

**Dustproof and waterproof: IP67**

Remarkable waterproof and dustproof performance  
One-touch testing for all 4 ground types



Accuracy guaranteed for 1 year  
Product warranty for 3 years



**2-pole  
method**

**3-pole  
method**

**CAT IV 100 V  
CAT III 150 V  
CAT II 300 V**

**Bluetooth®**  
GENNECT Cross  
(with Z3210)



### Dustproof and waterproof enclosure for robust performance in the field

Since the FT6031-50's enclosure is designed to keep out dust, it can be used with peace of mind in settings where it would be exposed to mud and dust. And if the instrument gets dirty, it can be rinsed clean with water.



### Accurately measures 5 Ω High precision & zero-adjustment

The FT6031-50 delivers high accuracy of  $\pm 1.5\%$  rdg.  $\pm 8$  dgt. The zero-adjustment function aids in delivering even better accuracy by canceling the wiring resistance of long measurement cable runs.



### Excellent noise resistance Allowable ground potential: 25.0 V RMS

Even in an environment where the ground potential is 25 V RMS, stable ground resistance can be measured.



### The tolerance for the supplemental grounding electrode's resistance: 50 kΩ

It eliminates the inconvenience of reinserting the auxiliary grounding rod over and over again due to increased soil resistance of dry soil or other non-optimal conditions, saving working time. The grounding rod is thin making it easier to insert and remove, and is made of hard, rust-resistant stainless steel.



### Tangle- and twist-free measurement cord winders

Measurement cord retrieval is a time-consuming part of ground resistance measurement. The FT6031-50's newly developed winders allow cords to be rewound about twice as quickly as with conventional reels.



### Add wireless communication capability by connecting Wireless Adapter Z3210

Transfer measurements to your phone or tablet. Generate reports with site photos and drawings with the free app GENNECT Cross

## Basic specifications

Measurement system	Two-pole method or three-pole method		
Measurement range	20 Ω (0 to 20.00 Ω)	200 Ω (0 to 200.0 Ω)	2000 Ω (0 to 2000 Ω)
Accuracy	$\pm 1.5\%$ rdg. $\pm 8$ dgt.	$\pm 1.5\%$ rdg. $\pm 4$ dgt.	$\pm 1.5\%$ rdg. $\pm 4$ dgt.
Ground potential	0 to 30.0 V RMS Accuracy: $\pm 2.3\%$ rdg. $\pm 8$ dgt. (50/60 Hz), $\pm 1.3\%$ rdg. $\pm 4$ dgt. (DC)		
Allowable ground potential	25.0 V RMS (DC or sine wave)		
Operating temperature and humidity	-25°C to 65°C*1 (non-condensing)		
Storage temperature and humidity	-25°C to 65°C (-13°F to 149°F): 80 % RH or less (non-condensing)		
Dustproof and waterproof	IP65/IP67 (EN60529)		
Applicable standards	Safety: EN 61010 (main unit), EN 61010 (measuring circuit); EMC: EN 61326; earth testers: EN 61557		
Power supply	LR6 alkaline battery x4, possible number of measurements for one set of batteries: 500 times (measurement conditions: three-pole method, measuring 10 Ω at 10-second intervals without Z3210 installed)		
Dimensions and mass	185 mm (7.28 in.) W × 111 mm (4.37 in.) H × 44 mm (1.73 in.) D, 570 g (20.1 oz.) (including batteries and protector, excluding terminal covers and other accessories)		

\*1: -25°C to 40°C, -13°F to 104°F (80% RH or less), 40°C to 45°C, 104°F to 113°F (60% RH or less), 45°C to 50°C, 113°F to 122°F (50% RH or less), 50°C to 55°C, 122°F to 131°F (40% RH or less), 55°C to 60°C, 131°F to 140°F (30% RH or less), 60°C to 65°C, 140°F to 149°F (25% RH or less)

See p. 12 for included accessories and options sold separately

# CLAMP ON EARTH TESTER FT6380-50

## Easy ground pole resistance measurement with super slim jaw

For multi-grounded systems only



**CS** **CE**  
Accuracy guaranteed for 1 year  
Product warranty for 3 years

**Clamp-on method**

**Current measurement  
True RMS**

**CAT IV 600 V**

**Bluetooth®  
GENNECT Cross  
(with Z3210)**



**Easy-to-read back light LCD**  
With the bright back light, you can easily read the measurement value even in dark locations.

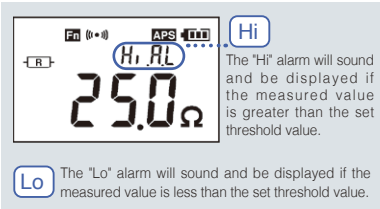

**Alarm Function**  
Set the alarm to audibly and visually notify yourself that the resistance or current value exceeds the threshold.

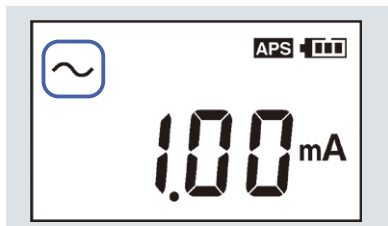

**Current measurement (RMS value display)**  
Measure leak current with highly sensitive 0.01 mA resolution.  
Measure load current up to the 60.0 A range.

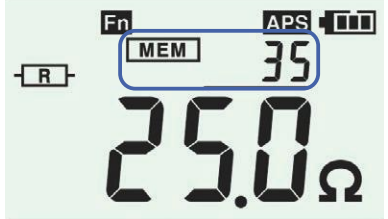

**Large storage capacity (up to 2,000 values)**  
You can store up to 2,000 measurement values in the field and utilize them in your office later.



**Transport to GENNECT Cross**  
GENNECT Cross, a free app designed specifically for use with Hioki measuring instruments, lets you check and manage measurement results and create reports. Data can be smoothly managed in the field by linking with photos, maps and drawings taken at the measurement site.



**Wireless transmission of measurements to smartphones and tablets**  
Just connect the optional Z3210 Wireless Adapter to your Hioki compatible instrument to make it Bluetooth® ready.

Location	Circuit no.	Ref. value	Measurement place	Value (MΩ)
A Block Circuit Breaker A	L-A	0.1MΩ	R-E	101 M Ohm
			S-E	101 M Ohm
			T-E	101 M Ohm
			R-S	65.4 M Ohm
			S-T	
B Block Circuit Breaker A	L-B	0.1MΩ	T-R	
			R-E	
			S-E	
			T-E	

**Transport to the Excel® file**  
Open an Excel® file and select a cell. When the "hold" function is activated (by pressing or auto-hold), the measured values will be transferred to the computer and entered into the selected cell.

## Applications

Multiple grounds can be easily checked with the clamps.

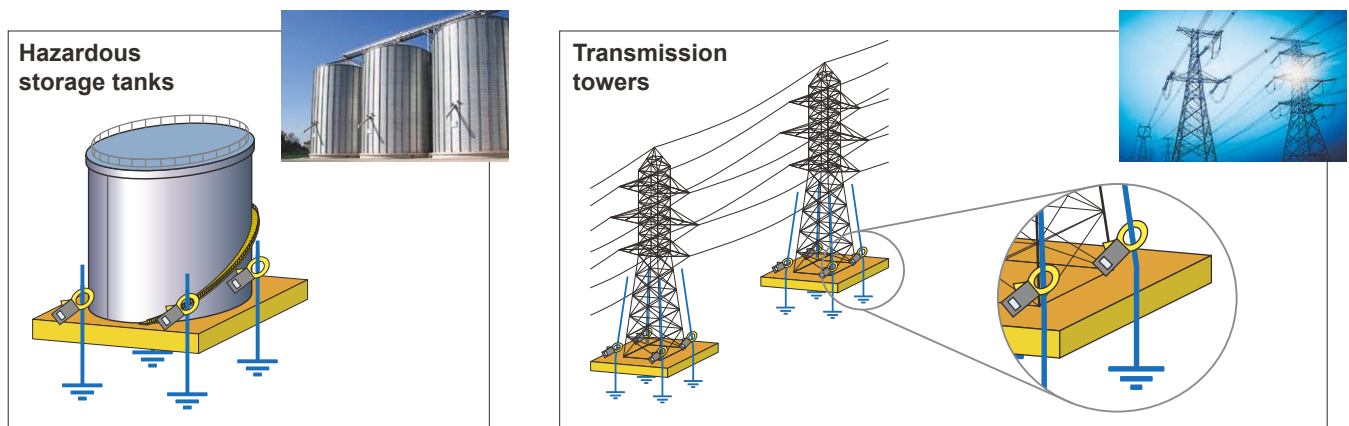

## Measurement precaution

In measuring ground resistance of poles for multi-grounded systems, the number of ground poles influences the accuracy of measurement. If there are few ground poles, the ground resistance of that pole will be measured as higher than the actual value. On the other hand, the more poles there are, the closer the measured value of that pole will be to its actual value. It is up to the skilled technician to take all of these factors into account to accurately measure the ground poles for multi-grounded systems.

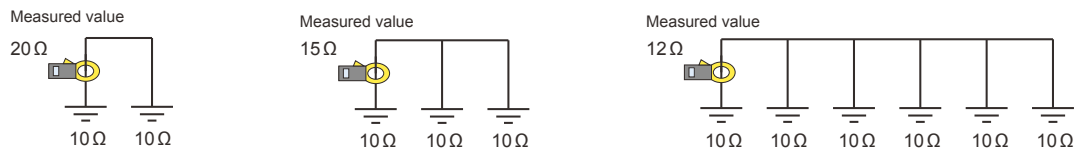

## Basic specifications

Measurement principle	Instrument has two cores for voltage injection and current measurement. The total circuit loop resistance is calculated from the defined voltage and measured current. Note: It is for multi-grounded systems only. In a multi-grounded system, the larger the number of ground poles, the more accurate the measured value.
Ground resistance range	0.20 Ω (0.01 Ω resolution) to 1600 Ω (20 Ω resolution), 10 ranges; zero suppression: less than 0.02 Ω; accuracy: $\pm 1.5\%$ rdg. $\pm 0.02 \Omega$
AC current range	20.00 mA (0.01 mA resolution) to 60.0 A (0.1 A resolution), 5 ranges; zero suppression: less than 0.05 mA; accuracy: $\pm 2.0\%$ rdg. $\pm 0.05$ mA (30 to 400 Hz, true RMS); crest factor: 5.0 or less (for the 60 A range, 1.7 or less)
Maximum input current (current measurement)	100 A AC continuous, 200 A AC for 2 minutes or shorter (at 50/60 Hz, requires derating at frequency)
Maximum rated terminal-to-ground voltage	600 V AC measurement category IV (anticipated transient overvoltage 8000 V)
Memory function	2000 values
Alarm function	It beeps when measured value is less than or greater than threshold (resistance/current measurement)
Harmonic levels	Current harmonic levels up to 30th, content factor, total harmonic distortion ratio (harmonics can be displayed with our free app GENNECT Cross when the Z3210 installed.)
Other functions	Data hold, backlight, filter, auto power save, wireless communication (with Z3210 installed)
Dust-proof and waterproof	IP40 (EN60529) with jaws closed
Applicable standards	Safety: EN61010; EMC: EN61326
Power supply	LR6 alkaline battery $\times 2$
Continuous operating time per battery set	Approx. 40 hours (25 Ω measurement, backlight off, without Z3210 installed) Approx. 35 hours (25 Ω measurement, backlight off, with Z3210 installed and using wireless communications)
Dimensions and mass	Approx. 73 mm (2.78 in.) W $\times$ 218 mm (8.58 in.) H $\times$ 43 mm (1.69 in.) D, approx. 620 g (21.87 oz.) (except for the battery)

## Included accessories

- Carrying Case
- Resistance Check Loop (1 Ω  $\pm 2\%$ , 25 Ω  $\pm 1\%$ )
- Strap
- LR6 Alkaline battery  $\times 2$
- Instruction manual



Carrying Case

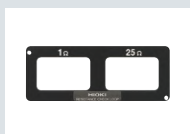

Resistance Check Loop

## Option sold separately



WIRELESS ADAPTER  
Z3210

FT6380-50 and Z3210 are also sold as a set (FT6380-90)

# ANALOG EARTH TESTER

## FT3151

### Ensuring safe, reliable measurement

#### Rewind with ease

Accuracy guaranteed for 1 year  
Product warranty for 3 years



2-pole  
method

3-pole  
method

CAT II 300 V

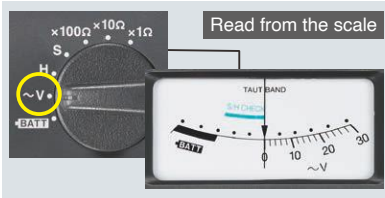

#### Ground potential check $\sim V$

Easily check for ground potential. Distorted ground potential can result in measurement errors, so it's important to take countermeasures, for example by turning off electrical connected to or influencing the ground.

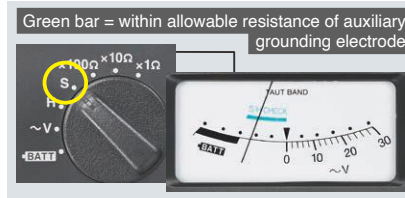

#### Auxiliary grounding resistance check $H(C)$ $S(P)$

If the ground resistance at the auxiliary electrode is too high, the measurement will fail. Turn the dial to S and H to see if needle falls within the green bar, meaning that each electrode is not exceeding allowable resistance (5 k $\Omega$ ).



#### Turn the knob to align the needle to the current detector's [ $\nabla$ ] mark.

If the ammeter's needle wavers...



1. Turn the knob to align the ammeter with the zero point.
2. Change the measurement current frequency to make the instrument less susceptible to the effects of harmonics

#### Basic specifications

Measurement method	AC potential difference detection method (Two-pole method or three-pole method)		
Measurement range	10 $\Omega$ (0 to 11.5 $\Omega$ )	100 $\Omega$ (0 to 115 $\Omega$ )	1000 $\Omega$ (0 to 1150 $\Omega$ )
Nominal Deviation	$\pm 0.25 \Omega$	$\pm 2.5 \Omega$	$\pm 25 \Omega$
Ground potential measurement	0 to 30 V; nominal deviation: $\pm 3.0\%$ f.s.		
Operating temperature and humidity	0°C to 40°C (32°F to 104°F), 80% rh or less (non-condensing)		
Storage temperature and humidity	-10°C to 50°C (14°F to 122°F), 80% RH or less (non-condensing)		
Dustproof and waterproof	IP40 (EN60529)		
Applicable standards	Safety (instrument/measurement/circuitry): EN 61010; EMC: EN 61326; earth testers: EN 61557		
Power supply	LR6 (AA) alkaline battery $\times 6$ , 1100 times operation (at 30 sec. measurement and 30 sec. rest cycle, 575 Hz mode, 100 $\Omega$ at auxiliary electrode, measuring 10 $\Omega$ in 1 $\Omega$ range)		
Dimensions and mass	164 mm (6.46 in.) W $\times$ 119 mm (4.69 in.) H $\times$ 88 mm (3.46 in.) D, 760 g (26.8 oz.)		

#### Dramatically faster set-up and break-down



Prep

#### Easy to drive into the ground

The auxiliary grounding rod is thin (for easier penetration), hard, and rust-resistant stainless steel. (Variations in the thickness of auxiliary grounding rods cause almost no change in their ground resistance.)



Cleanup

#### Tangle- and twist-free

Easily rewind measurement cords, even if they're 20 m long

#### Common to FT6031-50 and FT3151

To ensure safety, use the separately sold Test Lead L9787 when making measurements using the two-pole method.

#### Included accessories



- CARRYING CASE C0106
- AUXILIARY EARTHING ROD L9840 (2 piece set, stainless steel, 270 mm [10.63 in.] long)
- MEASUREMENT CABLE L9842-11 (yellow 10 m [32.81 ft.] long, equipped with winder)
- MEASUREMENT CABLE L9842-22 (red 20 m [65.62 ft.] long, equipped with winder)
- MEASUREMENT CABLE L9841 (alligator clip, black 4 m [13.12 ft.] long)
- LR6 alkaline battery  $\times 6$ , instruction manual  $\times 1$

#### Options sold separately



MEASUREMENT CABLE L9843-51  
Yellow 50 m (164.06 ft.) long

MEASUREMENT CABLE L9843-52  
Red 50 m (164.06 ft.) long

MEASUREMENT CABLE L9844  
For grounding terminal board, red/yellow/black each 1.2 m (3.94 ft.) long

TEST LEAD L9787  
For two-pole method, indoor use only, red and black each 1.2 m (3.94 ft.) long

EARTH NETS 9050  
2 sheets in set

SHOULDER STRAP Z5022 (for FT3151)

WIRELESS ADAPTER Z3210

Z3210 is not compatible with the FT3151

The Bluetooth® word mark and logos are registered trademarks owned by Bluetooth SIG, Inc. and any use of such marks by HIOKI E.E. CORPORATION is under license.  
Note: company names and product names appearing in this brochure are trademarks or registered trademarks of various companies.

# HIOKI

HIOKI E. E. CORPORATION

DISTRIBUTED BY

#### HEADQUARTERS

81 Koizumi,  
Ueda, Nagano 386-1192 Japan  
<https://www.hioki.com/>



Scan for all regional contact information