



From Production Lines to Research and Development A New Series of LCR Meters to Meet Your Applications

LCR METER Models IM3523, IM3533, and IM3533-01 are highly cost-effective testers that provide greater performance and better functionality than previous HIOKI models, such as a high basic accuracy of $\pm 0.05\%$, a wide measurement frequency from 1 mHz (40 Hz for the IM3523) to 200 kHz, high-speed measurement of up to 2 ms, highly reliable measurement using the contact-check function, and measurement of turn ratio and mutual inductance. Select the best model according to your application, from production lines to research and development.

For Production Lines The Perfect Impedance Analyzer

Product Lineup



*1 The check and double-check marks in the "Usage" rows indicate the recommendation level. The double-check mark represents a highly recommended application.

Model		LCR METER IM3523	LCR METER IM3533	LCR METER IM3533-01
Usage ^{*1}	Research and development	✓	✓	✓✓
	Transformer and coil production	✓	✓✓	✓✓
	LCR component production	✓✓	✓✓	✓✓
Measurement items	Basic measurement items	Z (impedance [Ω]) Y (admittance [S]) θ (phase angle [°]) Rs (equivalent series resistance = ESR [Ω]) Rp (parallel resistance [Ω]) X (reluctance [Ω]) G (conductance [S]) B (susceptance [S]) Ls (series inductance [H]) Lp (parallel inductance [H]) Cs (series capacitance [F]) Cp (parallel capacitance [F]) Q (Q factor (Q = 1/D)) D (loss coefficient = tanδ)		
	Rdc (direct current resistance)	✓	✓ (with temperature compensation function)	
	Transformer measurement	–	N (turn ratio) M (mutual inductance) ΔL (inductance difference)	
	Temperature T	–	✓	
Basic accuracy		±0.05%rdg.		
Measurement frequency		40 Hz to 200 kHz	1 mHz to 200 kHz	
Measurement voltage		5 mV to 5 V	5 mV to 5 V/2.5 V ²	
Measurement time		2 ms	2 ms	
Comparator		2 items: HI/IN/LO, ABS/%/Δ%		
BIN measurement		Main item: 10 categories Sub-item: 1 category	2 items: 10 categories	
Cable length		0 m/1 m	0 m/1 m	0 m/1 m/2 m/4 m
Contact check		4-terminal contact check (threshold change) / Hi-Z reject		
Internal DC bias measurement		–	–5 V to 5 V	
Sweep measurement		–	–	Frequency 2 to 801 points
Display		Monochrome LCD	Color TFT 5.7-inch LCD touch panel	
Interface	EXT I/O, USB	✓	✓	
	USB flash drive	–	✓	
	RS-232C, GP-IB, LAN	Option (select one)		

Highlighted functions in bold-type in the IM3533 and IM3533-01 section are more advanced than those of the IM3523.

² 2.5 V in the low impedance high accuracy mode

For Lead Components and Surface Mounted Devices (SMDs) Probes & Test Fixtures

Please use the probes specified below. All probes are constructed with a 1.5D-2 V coaxial cable.

Probes and Test Fixtures for Lead Components

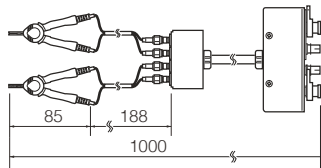

FOUR-TERMINAL PROBE L2000

Cable length 1 m (3.28 ft), DC to 8 MHz, impedance characteristics of 50 Ω, 4-terminal pair configuration, measurable conductor diameter: ø0.3 mm (0.01 in) to ø5 mm (0.20 in) max.

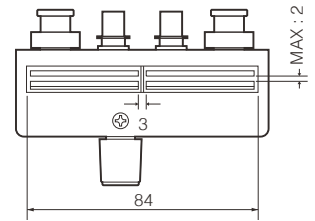
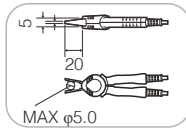

TEST FIXTURE 9262

Direct connection type, DC to 8 MHz, measurable conductor diameter: ø0.3 mm (0.01 in) to ø2 mm (0.08 in) max.

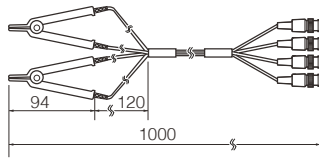

FOUR-TERMINAL PROBE 9140-10

Cable length 1 m (3.28 ft), DC to 200 kHz, impedance characteristics of 50 Ω, 4-terminal pair configuration, measurable conductor diameter: ø0.3 mm (0.01 in) to ø5 mm (0.20 in) max.

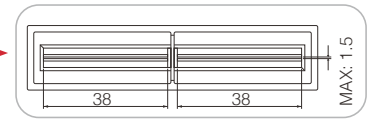
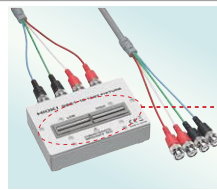
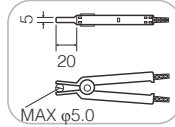

TEST FIXTURE 9261-10

Cable length 1 m (3.28 ft), DC to 8 MHz, impedance characteristics of 50 Ω, 4-terminal pair configuration, measurable conductor diameter: ø0.3 mm (0.01 in) to ø1.5 mm (0.06 in) max.

Test Fixtures for SMDs

Applicable SMD size

✓ : Measurable
▲ : Not recommended

SMD type		Length L (mm)	Width W (mm)	Applicable SMD size					
JIS CODE	EIA CODE			9263	9677	9699	L2001	IM9100	IM9110
0201	008004	0.25	0.125						✓
0402	01005	0.40	0.20					✓	
0603	0201	0.60	0.30		▲		✓	✓	
1005	0402	1.00	0.50		✓		✓	✓	
1608	0603	1.60	0.80	▲	✓	✓	✓	✓	
2012	0805	2.00	1.25	✓	▲	✓	✓		
3216	1206	3.20	1.60	✓		▲	✓		
3225	1210	3.20	2.50	✓		▲	✓		
4532	1812	4.50	3.20	✓			✓		
5750	2220	5.70	5.00	✓			✓		

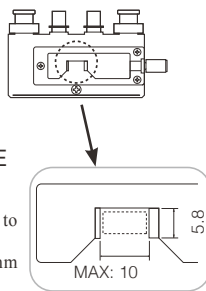

SMD TEST FIXTURE 9263

Direct connection type, DC to 8 MHz, Test sample dimensions: 1 mm (0.04 in) to 10 mm (0.39 in)

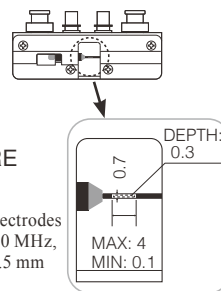

SMD TEST FIXTURE 9677

Direct connection type, Electrodes on side for SMD, DC to 120 MHz, Test sample dimensions: 3.5 mm ±0.5 mm (0.14 in ±0.02 in)

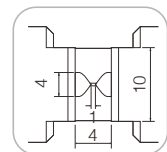

SMD TEST FIXTURE 9699

Direct connection type, Electrodes on bottom for SMD, DC to 120 MHz, Test sample dimensions: 1.0 mm (0.04 in) to 4.0 mm (0.16 in) wide, maximum 1.5 mm (0.06 in) high



SMD TEST FIXTURE IM9100

Measurable range: DC to 8 MHz, For SMD with electrodes on bottom, Measurable sample sizes: 01005 to 0402 (EIA) 0402 to 1005 (JIS), Direct connection type



SMD TEST FIXTURE IM9110

Measurable range: DC to 1 MHz, For SMD with electrodes on side, Measurable sample sizes: 008004 (EIA), 0201 (JIS), Please contact Hioki for information about other sizes, Direct connection type



PINCHER PROBE L2001

Cable length 730 mm (2.40 ft), DC to 8 MHz, characteristic impedance of 50 Ω, tip electrodes featuring 2-terminal design (4-terminal pair design between electrode and measurement unit), tip electrode spacing of 0.3 to approx. 6 mm (0.01 to approx. 0.24 in), Ships standard with one set of IM9901

Options for L2001
Replaceable contact tips

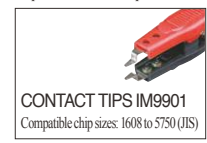

CONTACT TIPS IM9901
Compatible chip sizes: 1608 to 5750 (JIS)



CONTACT TIPS IM9902
Compatible chip sizes: 0603 to 5750 (JIS)

Features

High-Speed, High-Accuracy, and Easy-to-Use

Basic Performance

IM3523

IM3533

IM3533-01

● Wide measurement frequency range

The measurement frequency can be freely set to DC or any value in the 1 mHz (40 Hz for the IM3523) to 200 kHz range at high resolution (five-digit resolution [1 mHz resolution for less than 100 Hz]). This makes it possible to measure the resonant frequency and perform measurement and evaluation under conditions close to actual conditions.

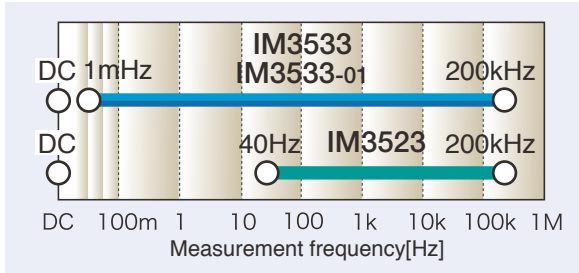

● Wide setting range for measurement voltage and current

In addition to normal open-loop signal generation, these models enable voltage/current dependent measurement in constant voltage/current modes.

The signal levels can be set over wide ranges from 5 mV to 5 V and from 10 μ A to 50 mA. (The setting range of measurement signal levels varies depending on the frequency and measurement mode.)

● Basic accuracy $\pm 0.05\%$

The basic accuracy of Z is $\pm 0.05\%$. This fits a wide array of applications ranging from the inspection of parts to research and development measurements.

● Accuracy guaranteed at measurement cables of up to 4 meters

Four-terminal pair configuration reduces the influence of measurement cables and accuracy is guaranteed at the measurement cable lengths of up to 4 meters. This simplifies the wiring of automated machinery. With models IM3523 and IM3533, accuracy is guaranteed at measurement cable lengths of up to 4 meters with the cable length correction set to 1 meter. (The frequency range for which accuracy is guaranteed varies depending on the cable length.)

● 15 parameters can be measured

The following parameters can be measured and selected parameters can be imported to a computer: Z, Y, θ , R_s (ESR), R_p , R_{dc} (DC resistance), X, G, B, Ls, Lp, Cs, Cp, D (tan δ), and Q.

● Fastest measurement time 2 ms

The fastest measurement time of 2 ms at a measurement frequency of 1 kHz and the measurement speed FAST improves the inspection throughput used in automated machinery.

Functions and Features for LCR Measurements on Production Lines

IM3523

IM3533

IM3533-01

● Contact check function incorporated

The contact check function for four-terminal measurement and the Hi-Z reject function for two-terminal measurement ensure the measurement electrode is in contact with the measurement object during measurement.

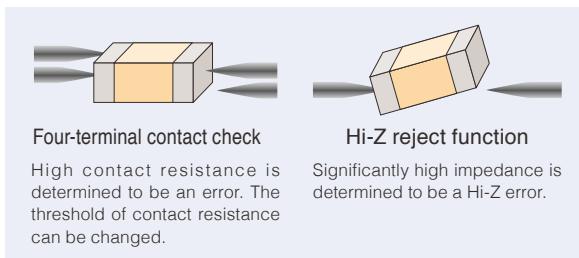

● Continuous measurement under different measurement conditions

Different measurement items can be measured continuously under different measurement conditions (frequency, level, and mode).

● Protection against charged capacitors*

To address situations when a charged capacitor is incorrectly connected to the measurement terminal, the protection function* has been improved to 10 times of the amount of residual charge of the previous model 3522-50.

* This function does not guarantee the measurement of charged capacitors. Be sure to discharge the capacitor before measuring it.

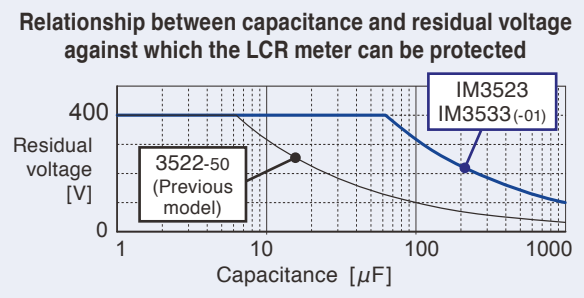

Advantage #1

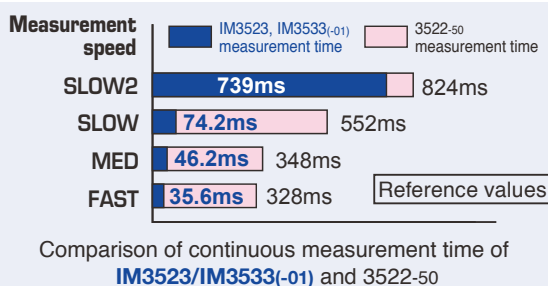

With continuous measurement under varying measurement conditions such as C-D + ESR measurement of capacitors, the total measurement time has been shortened significantly from the previous HIOKI model 3522-50. In addition to the reduction of the time required for individual measurements, the time required to change ranges such as a frequency range has been reduced significantly.

Features of LCR Meter Model IM3523

Integration into Production Lines and Automated Machinery



- Easy setup using a numeric keypad on a simple, easy-to-read monochrome LCD

IM3523

A simple user interface is provided with a high-contrast graphic LCD display, function keys, and numeric keypad. For numeric value settings such as the comparator setting, the numeric keypad can be used to enter numbers easily and quickly.

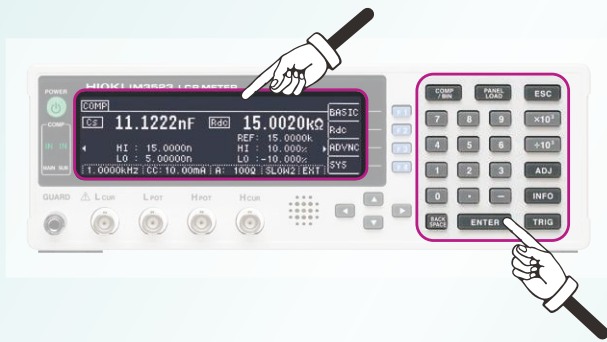

- General specifications of the IM3523

Measurement items	Basic measurement items	Z, Y, θ , Rs, Rp, X, G, B, Ls, Lp, Cs, Cp, Q, D
	Rdc	✓
	Transformer measurement	-
	Temperature T	-
Basic accuracy		$\pm 0.05\%$ rdg.
Measurement frequency		40 Hz to 200 kHz
Measurement voltage		5 mV to 5 V
Measurement time		2 ms
Comparator		2 items: HI/IN/LO, ABS/%/ $\Delta\%$
BIN measurement		10 main classifications/1 sub-classification
Cable length		0 m/1 m
Contact check		4-terminal contact check (threshold change) / Hi-Z reject
Internal DC bias measurement		-
Sweep measurement		-
Display		
Monochrome LCD		
Interface	EXT I/O, USB	✓
	USB flash drive	-
	RS-232C, GP-IB, LAN	Option (select one)

- Compact size ideal for integration into production lines and automated machinery

IM3523

The size is the same as that of compact measuring instruments for bench use - smaller than the previous model - fitting easily into automated machinery and production processes.

- Comparator

IM3523

In LCR mode, the meter allows for Hi, IN, and Lo judgments of two types from the measurement items. For the judgment method, % setting and $\Delta\%$ setting are available in addition to absolute value setting. If continuous measurement is used, judgments which span over multiple measurement conditions and measurement items are possible.

- BIN measurement

IM3523

With the IM3523, the main item can be classified into 10 categories and out of range, and the sub-item into 1 category and out of range.

Functions and Features Suitable for Measurements and Inspection on Production Lines

IM3523

IM3533

IM3533-01

- Auto-range control function

When a measurement object crosses over multiple ranges, measurement can be tailored by controlling the moving-range of the auto-range. Measurement can be performed by taking advantage of both the wide measurement range of the auto-range and the reduction of the measurement time achieved by completing a search only in the specified range.

- Individual items of two continuous measurements can be output from EXT I/O

For two types of continuous measurement judgment items, individual judgment results can be captured from EXT/IO. This makes it possible to perform more detailed inspections and sorting.

Functions and Features to Reduce the Time Needed to Prepare for Measurement

IM3523

IM3533

IM3533-01

- Limit-linked range setting and range-linked setting function

The optimal range is automatically set according to the set reference value or range. In addition, the measurement conditions can be automatically set to be optimized according to the change in the range, reducing the preparation time.

- OPEN/SHORT compensation area setting function

When the measurement frequency range is limited, OPEN/SHORT compensation can be executed by limiting the compensation area to the actual frequency range being measured. The time required to execute OPEN/SHORT compensation is then significantly reduced compared to the time needed to compensate the entire range.

Features of LCR Meter Model IM3533

Winding, Coil and Transformer Production



● Transformer measurement **IM3533** **IM3533-01**
 Turn ratio N, mutual inductance M, and inductance difference ΔL can be measured on the transformer measurement screen.

● Rdc measurement with temperature compensation² **IM3533** **IM3533-01**
 For Rdc measurement of inductor and transformer windings, measurement can be performed while compensating for temperature.
² Temperature Probe 9478 (option) is required for Rdc measurement with temperature compensation.

● Simultaneously display 4 parameters (for normal measurement) **IM3533** **IM3533-01**
 For normal measurement, four parameters can be displayed simultaneously. This makes it easy to check parameters by comparing them with each other.

● General specifications of the IM3533

Measurement items	Basic measurement items	Z, Y, θ , Rs, Rp, X, G, B, Ls, Lp, Cs, Cp, Q, D
	Rdc	✓ (with temperature compensation function)
	Transformer measurement	N, M, ΔL
	Temperature T	✓
Basic accuracy		$\pm 0.05\%$ rdg.
Measurement frequency		1 mHz to 200 kHz
Measurement voltage		5 mV to 5 V/2.5 V ^{†1}
Measurement time		2 ms
Comparator		2 items: HI/IN/LO, ABS/%/ $\Delta\%$
BIN measurement		2 items: 10 classifications
Cable length		0 m/1 m
Contact check		4-terminal contact check (threshold change) / Hi-Z reject
Internal DC bias measurement		-5 V to 5 V
Sweep measurement		-
Display		Color TFT 5.7-inch LCD touch screen
Interface	EXT I/O, USB	✓
	USB flash drive	✓
	RS-232C, GP-IB, LAN	Option (select one)

^{†1} 2.5 V in the low impedance high accuracy mode

● Internal DC bias -5 V to 5 V **IM3533** **IM3533-01**
 The instruments can perform measurements alone by applying a DC bias of up to ± 5 V. This is reassuring when measuring polar capacitors such as a tantalum capacitor.

● BIN measurement: Two items are classified into 10 categories **IM3533** **IM3533-01**
 Two items can be classified into 10 categories and out of range. This function is useful for sorting out composite parts and performing advanced sorting.

Functions and Features to Simplify the Operation of LCR Measurements

IM3533 **IM3533-01**

● Instrument mode indicators
 Indicators allow you to identify the operating conditions of the instrument even when the touch screen is off.

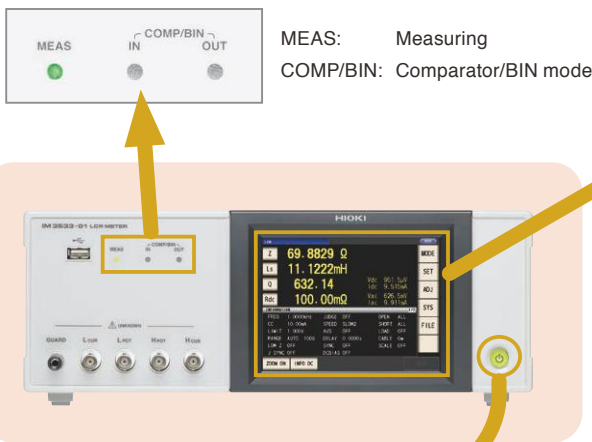

● Easy touch screen operation
 A touch screen with intuitive operation is inherited from previous models. Furthermore, the incorporation of a color LCD means the display is easy to view, and outstanding, easy-to-understand operability helps improve work efficiency.



Measurement screen (LCR mode)



Measurement parameter input screen



Setting items of basic measurement conditions

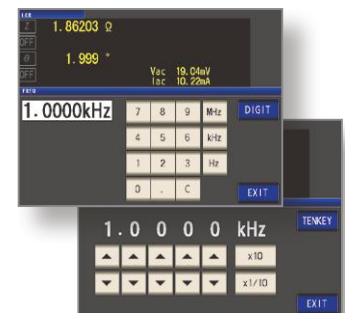

Frequency setting (numeric keypad input and up/down input)

● Power indicator
 The power indicator allows you to identify the on/off status of the LCR meter even when integrated into automated machinery or the LCD display is off.

Power on: green
 Standby: red

Easily change the measurement conditions such as the measurement frequency and measurement signal level while you monitor the measurement values.

Features of LCR Meter Model IM3533-01

Research and Development and Electrochemistry



● Frequency sweep

IM3533-01

Measurements can be performed automatically at up to 801 frequency points by specifying the frequency range or in the frequency list mode. The measurement results can be saved to a USB flash drive or to a computer via an interface, which then can be used to perform frequency analysis of samples.

FREQ[Hz]	Z[Ω]	θ[°]
605.83	20.4452k	-88.680
622.09	19.9123k	-88.673
638.79	19.3944k	-88.664
655.94	18.8899k	-88.653
673.55	18.3956k	-88.644
691.63	17.9173k	-88.634
710.20	17.4492k	-88.619
729.27	16.9939k	-88.606
748.84	16.5517k	-88.588
768.95	16.1239k	-88.574
789.59	15.7055k	-88.570
810.79	15.2958k	-88.564

Measurement screen (frequency sweep)

● General specifications of the IM3533-01

Measurement items	Basic measurement items	Z, Y, θ, Rs, Rp, X, G, B, Ls, Lp, Cs, Cp, Q, D
	Rdc	✓ (with temperature compensation function)
	Transformer measurement	N, M, ΔL
	Temperature T	✓
Basic accuracy		±0.05%rdg.
Measurement frequency		1 mHz to 200 kHz
Measurement voltage		5 mV to 5 V/2.5 V ⁻¹
Measurement time		2 ms
Comparator		2 items: HI/IN/LO, ABS/%/Δ%
BIN measurement		2 items: 10 classifications
Cable length		0 m/1 m/2 m/4 m
Contact check		4-terminal contact check (threshold change) / Hi-Z reject
Internal DC bias measurement		-5 V to 5 V
Sweep measurement		Frequency 2 to 801 points
Display		Color TFT 5.7-inch LCD touch screen
Interface	EXT I/O, USB	✓
	USB flash drive	✓
	RS-232C, GP-IB, LAN	Option (select one)

⁻¹ 2.5 V in the low impedance high accuracy mode

● Cable length setting to 0 m/1 m and 2 m/4 m **IM3533-01** with guaranteed accuracy

The cable length can be set to 0 m/1 m (common for the series) and to 2 m/4 m for the IM3533-01. Even when the measurement cable needs to be extended in laboratories and for automated machinery, the maximum performance can be ensured and the maximum accuracy can be guaranteed. When using an extension cable, be sure to refer to the instruction manual.

Functions and Features for LCR Measurements in Research and Development

IM3533 IM3533-01

● Measurable from low frequencies from 1 mHz

Measurements can be performed from low frequencies from 1 mHz at 1 mHz resolution^{*2}. The function can be used for the basic measurements of electrochemical applications.

^{*2} Five-digit resolution at 100 Hz or more.

● Low impedance high accuracy mode

Low impedance high accuracy mode can be used at 100 mΩ and in the 1 Ω range. Output resistance of 25 Ω can increase the measured current and thus improve the measurement accuracy. (The maximum applied current is 100 mA and the maximum applied voltage is 2.5 V)

This mode is useful during L measurement of low-inductance inductors for power supplies and ESR measurement of aluminum electrolytic capacitors.

Advantage #2

Low impedance high accuracy mode improves repeat accuracy

The IM3533 and IM3533-01 provide a low impedance high accuracy mode that improves repeat accuracy in low-impedance measurements.

Compared to the previous HIOKI model 3522-50, the measurement speed of C-D + ESR continuous measurement in FAST and MED modes has increased by one digit and the repeat accuracy (variation) of Rs has also been improved.

Continuous measurement time and repeat accuracy of Rs in C-D + ESR continuous measurement at 100 kHz (Sample: aluminum electrolyte capacitor 1.5 μF)

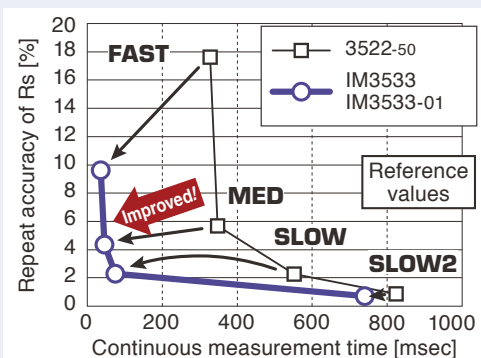

Capacitors and Inductors

C-D + ESR Measurement of Capacitors

IM3523 IM3533 IM3533-01



LCR mode [IM3523]
Cs and D display screen
(120 Hz measurement)



LCR mode [IM3523]
Rs display screen
(100 kHz measurement)



Continuous measurement
screen [IM3523]

Continuous measurement can be performed with high speed under multiple conditions!

C-D (120 Hz) and low ESR (100 Hz) measurement can be performed for functional polymer capacitors. Different measurement items can be measured continuously under different measurement conditions (frequency, level, and mode).

C Measurement of Polar Capacitors

IM3533 IM3533-01



LCR mode
When DC bias is set

A DC bias voltage may sometimes be applied to measure polar capacitors such as an electrolytic capacitor.

The IM3533(-01) can perform C-D measurement by applying a DC bias voltage of -5 V to 5 V without using an optional DC bias unit.

Rdc and L-Q Measurement of Inductors (Coils and Transformers)

IM3523 IM3533 IM3533-01



L and Q display screen
(1 kHz, 1 mA constant current
measurement)

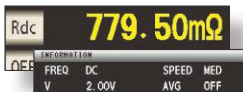

Rdc display screen
(DC measurement)



L, Q and Rdc continuous
measurement screen

L and Q (1 kHz, 1 mA constant
current measurement) and Rdc
(DC measurement) display
screen

L-Q (1 kHz, 1 mA constant current) and Rdc can be measured continuously and the measurement results can be displayed on the same screen.

Measurement with a constant current (CC) can be performed for current dependent elements such as coils incorporating cores, the inductance value of which varies depending on the applied current.

With the IM3533(-01), repeat accuracy during low impedance measurements has been improved from previous HIOKI models to ensure stable measurement of Rdc.

Advantage #3



Rdc temperature
compensation
setting screen

Enlarged view of
temperature
compensation
setting

Rdc measurement with temperature compensation*

The IM3533-01 provides Rdc measurement with temperature compensation, which makes it possible to manage winding resistance more accurately.

The low impedance high accuracy mode allows you to measure low-inductance inductors and low-Rdc inductors more accurately than previous HIOKI models.

* Temperature Probe 9478 (option) is required for Rdc measurement with temperature compensation.

Transformer Winding and Sweep Measurements

Variety of Transformer Winding Measurement Functions

IM3533 IM3533-01

In addition to the L-Q and Rdc measurements, the IM3533 and IM3533-01 enable you to measure the turn ratio N, mutual inductance M, and inductance difference ΔL that are required for the measurement of transformers.*

* Connections must be switched manually or a selector such as a scanner unit is required separately.

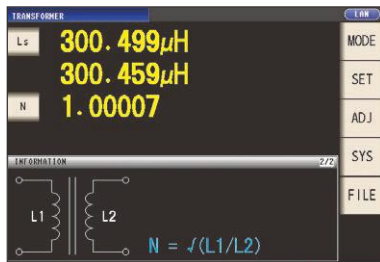

Transformer measurement mode
Turn ratio measurement (information) screen

N Turn ratio N measurement

- (1) Measure L (L_1) on the primary side
- (2) Measure L (L_2) on the secondary side
- (3) Calculate turn ratio N from L_1 and L_2

$$N = \sqrt{L_1/L_2}$$

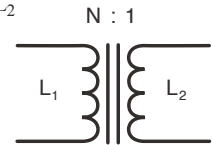

Transformer measurement mode
Turn ratio measurement and judgment screen

M Mutual inductance M measurement

- (1) Measure L (L_a) connected in series and in phase
- (2) Measure L (L_b) connected in series and in anti-phase
- (3) Calculate M from L_a and L_b

$$M = (L_a - L_b)/4$$

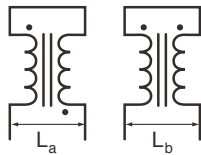

Transformer measurement mode
Mutual inductance measurement screen

ΔL Inductance difference ΔL measurement

- (1) Measure L (L_1) on the primary side
- (2) Measure L (L_2) on the secondary side
- (3) Calculate difference L from L_1 and L_2

$$\Delta L = L_1 - L_2$$

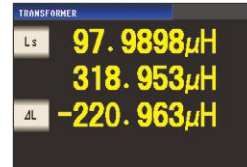

Transformer measurement mode
Inductance difference measurement screen

Sweep Measurement

IM3533-01

The IM3533-01 provides a frequency sweep measurement function that allows you to measure the inductance (L), capacitance (C), and frequency characteristics of samples such as composite components. The function is useful in research and development.

The bundled LCR sample application can be used to display a frequency characteristic list and graph on a computer screen.

FREQ(Hz)	Z(Ω)	θ(-)
605.83	20.4452k	-88.680
622.09	19.9123k	-88.673
638.79	19.3944k	-88.664
655.94	18.8899k	-88.653
673.55	18.3956k	-88.644
691.63	17.9173k	-88.634
710.20	17.4492k	-88.619
729.27	16.9939k	-88.606
748.84	16.5517k	-88.588
768.95	16.1239k	-88.574
789.59	15.7055k	-88.570
810.79	15.2958k	-88.564

Sweep measurement



USB flash drive

USB connection

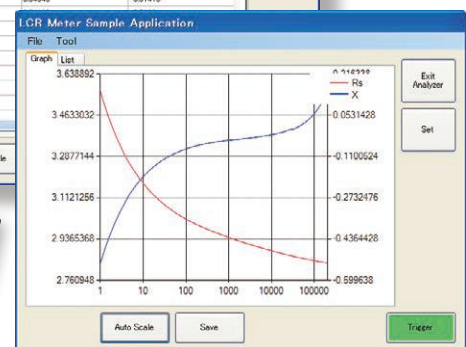
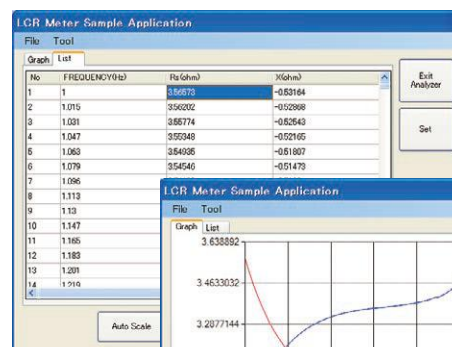

Sweep measurement results list and graph screens as shown in the bundled LCR sample application

Linking to PC Capturing Measurement Data

● Saving and loading data via front USB port

IM3533 **IM3533-01**

Measurement results and settings can be saved to a commercially available USB flash drive connected to the front USB port.

(The USB port on the front panel is specifically for a USB flash drive. Batch save all the measurement results to a USB flash drive after saving them to the internal memory of the IM3533(-01). Some USB flash drives may not be supported due to incompatibility issues.)

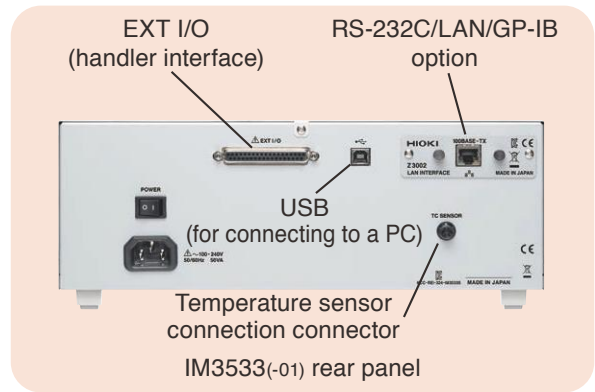
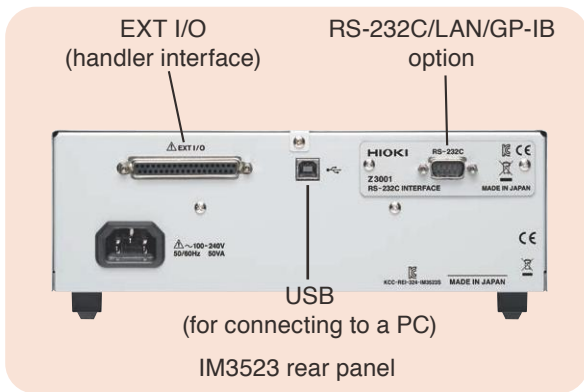
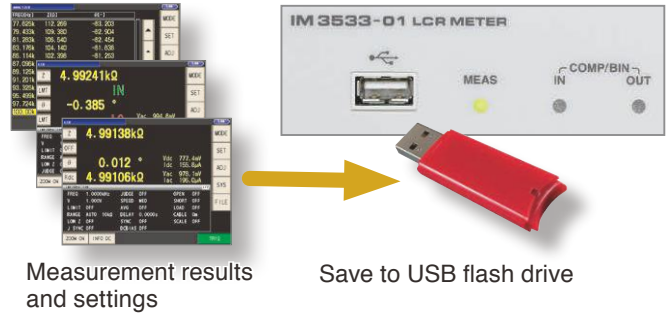

● Connecting to a PC via USB

IM3523 **IM3533** **IM3533-01**

The rear panel is standard equipped with a USB port.
(The USB port on the rear panel is specifically for connecting to a PC.)

Control the various functions of the IM3523 and IM3533(-01) from a PC and download measurement results.

(Excluding turning the power on/off and configuring some interface settings.)



● Connecting to a PC or PLC via RS-232C, LAN, or GP-IB (select one option) connection

IM3523 **IM3533** **IM3533-01**

When you need an RS-232C, LAN, or GP-IB interface, you can select any one option.

Control the various functions of the IM3523 and IM3533(-01) from a PC and download measurement results. (Excluding turning the power on/off and configuring some interface settings.)

Use an appropriate RS-232C cable in accordance with the connection method shown in the figure below. A crossover cable for interconnection can be used.

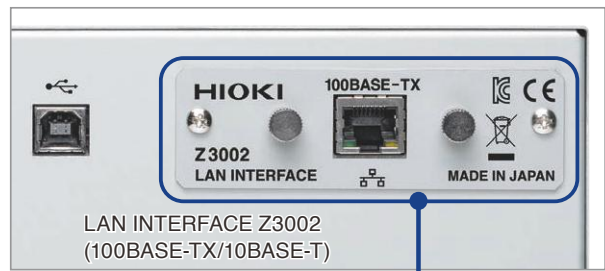
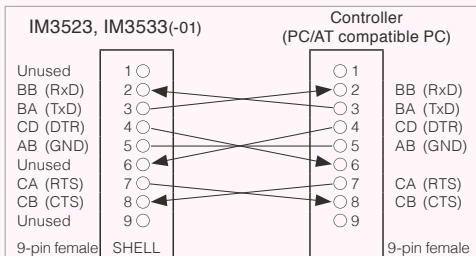

EXT I/O

● Handler (EXT I/O) interface

The handler (EXT I/O) interface enables output of an end of measurement signal and measurement result signal, and input of signals such as a measurement trigger signal to control the measuring instrument. Each of the signal lines is isolated from the measurement and control circuits, and the structure is designed to protect against noise.

When designing a control system using the EXT I/O interface, be sure to read the instruction manual and check the necessary technical information.

■ Example of Typical EXT I/O Timing (LCR Mode)

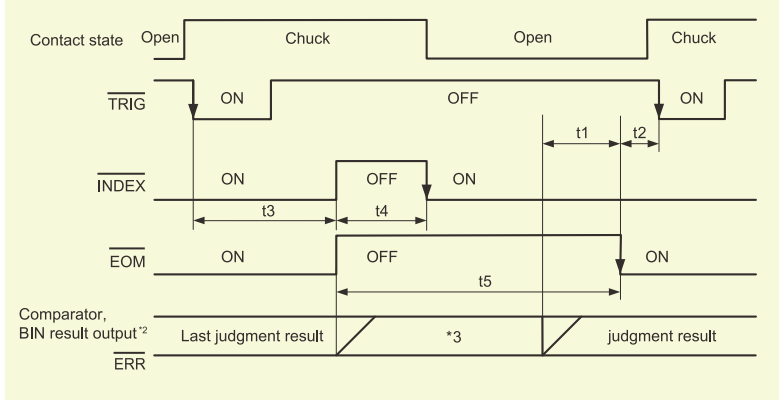

- t1: Delay setting time from comparator and BIN judgment results to EOM (LOW): 40 μs or longer *1
- t2: Minimum time from end of measurement to next trigger: 400 μs *1
- t3: Time from trigger to response by circuit: 700 μs *1
- t4: Minimum chuck time for which the chuck can be switched with INDEX (LOW): 220 μs *1
- t5: Measurement time: 600 μs *1

- *1: When the measurement speed is FAST and the range is HOLD.
- *2: IM3523 : MAIN-HI, MAIN-IN, MAIN-LO, SUB-HI, SUB-IN, SUB-LO, AND, BINx, OUT-OF-BINS, SUBNG
IM3533(-01): PARAX-HI, PARAX-IN, PARAX-LO, AND, BINx, OUT_OF_BINS
- *3: Reset at the same time as TRIG: HIGH
Not reset at the same time as TRIG: LOW

■ Approximate measurement speed

(at 1 kHz and when the screen display is OFF *4)

FAST	MED	SLOW	SLOW2
2 ms	6 ms	21 ms	301 ms

- *4: Add up all the applicable times in the following cases.
 - When OPEN/SHORT/LOAD compensation is executed: max 0.4 ms
 - When comparator measurement is executed: max 0.4 ms
 - When BIN measurement is executed: max 0.8 ms
 - When the screen display is ON: max 0.3 ms
 - When the memory function is ON: max 0.4 ms

■ EXT I/O signal list

● Input signals

TRIG	External trigger
LD0 to LD6	Panel number selection
LD_VALID	Panel load execution

● Output signals

EOM	End of measurement
INDEX	End of capture
ERR	Measurement error output
ISO_5 V	Internally isolated 5 V
ISO_COM	Internally isolated common

● Output signals (common signal line)

IM3523	IM3533, IM3533-01	
MAIN-HI, MAIN-IN, MAIN-LO, SUB-HI, SUB-IN, SUB-LO, AND, SUBNG	PARAX-HI, PARAX-IN, PARAX-LO (x=1,3), AND	Comparator judgment result output
BINx (x=1 to 10), OUT	BINx (x=1 to 10), OUT_OF_BINS	BIN judgment result output
No.n_x-HI, No.n_x-IN, No.n_x-LO (n=1,2; x=MAIN, SUB)	No.n_PARAX-HI, No.n_PARAX-IN, No.n_PARAX-LO (n=1,2; x=1,3)	Continuous measurement result output
—	HI, IN, LO, AND	Transformer mode

■ EXT I/O Electrical Specifications

● Inputs:

Photocoupler isolation: Non-voltage contact inputs (support for current sink output, negative logic)
Assert: 0 to 1 V (with 3 mA input)
De-assert: Open, or 5 to 30 V

● Outputs:

Photocoupler isolation: Open-collector NPN (support for current sink output, negative logic)
Max. 30 V and 50 mA per ch.
Residual voltage: Max. 1.5 V @50 mA, or 1 V @10 mA.

● Accessory Power Out (internally powered):

4.5 to 5 V DC @ 100 mA max.
Isolated from protective ground and measurement circuitry

■ Connectors

Connectors to use : 37-pin D-SUB female connector with #4-40 inch screws

Compliant connectors : DC-37P-ULR (solder type) and DCSP-JB37PR (insulation-displacement type)
For information on where to obtain connectors, consult your nearest HIOKI distributor.

■ EXT I/O Input and Output Circuits

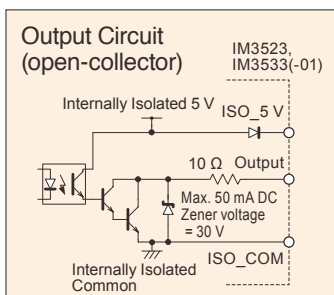
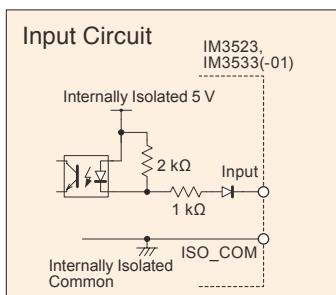

IM3523 / IM3533 Measurement Accuracy (Accuracy guaranteed for 1 year)

Conditions

Temperature and humidity ranges: 23°C ± 5°C, 80% rh or less (no condensation), at least 60 minutes after power is turned on, after performing open and short compensation

Measurement accuracy

The measurement accuracy is calculated based on the following equation.
Measurement accuracy = Basic accuracy × C × D × E × F × G

[C: Level coefficient]

V: Setting value (corresponds to V mode or equivalent) [V]

Excluding Rdc	Rdc
0.005 V to 0.999 V: 1+0.2/V 1 V: 1 1.001 V to 5 V: 1+2/V	2 V: 1

[D: Measurement speed coefficient]

Excluding Rdc	Rdc
FAST: 4 MED: 3 SLOW: 2 SLOW2: 1	FAST: 8 MED: 4 SLOW: 2 SLOW2: 1

[F: DC bias coefficient]

DC bias setting OFF: 1
DC bias setting ON: 2

[E: Measurement cable length coefficient]

fm: Measurement frequency [kHz]

Cable length	IM3523, IM3533		IM3533-01
	10 kΩ range and below	100 kΩ range and above	
0 m	1	1	1
1 m	1.2	1.2	1.2
2 m	1.5 + fm/100	1.5 + fm/20	1.5
4 m	2 + fm/50	2 + fm/10	2

Please use a coaxial cable with 50 Ω impedance characteristics and 4-terminal pair configuration.

Guaranteed accuracy range (frequency)

Cable length	IM3523, IM3533		IM3533-01
	10 kΩ range and below	100 kΩ range and above	
0 m	Up to 200 kHz	Up to 200 kHz	Up to 200 kHz (No limit)
1 m		Up to 100 kHz	
2 m		Up to 10 kHz	
4 m		Up to 10 kHz	

[G: Temperature coefficient] t: Operating temperature

When t is 18°C to 28°C: 1
When t is 0°C to 18°C or 28°C to 40°C: 1+0.1 × |t-23|

Basic accuracy (Z, θ) calculation expressions

The basic accuracy is calculated by selecting coefficients A and B from the basic accuracy table and using the calculation expressions below.

1 kΩ range and above:

$$\text{Accuracy} = A + B \times \left| \frac{10 \times Z_x}{\text{Range}} - 1 \right|$$

In the 1 kΩ range and above and 310 Ω range and below, the calculation expression of basic accuracy differs as shown in the left. For details, refer to the following calculation examples on page 13.

100 Ω range and below:

$$\text{Accuracy} = A + B \times \left| \frac{\text{Range}}{Z_x} - 1 \right|$$

Z_x is the actual impedance measurement value (Z) of the sample.

When temperature compensation is performed during Rdc measurement, add the following value to the calculation expression of basic accuracy.

$$\frac{-100 \alpha_{t_0} \Delta t}{1 + \alpha_{t_0} \times (t + \Delta t - t_0)} \quad [\%]$$

t₀: Reference temperature [°C]
t: Current ambient temperature [°C]
Δt: Temperature measurement accuracy
α_{t₀}: Temperature coefficient for t₀ [1/°C]

Basic accuracy table

Coefficients A and B

DC A is the accuracy of R (± % rdg.) B is the coefficient for the resistance of the sample	0.001 Hz (40 Hz) to 200 kHz Top A: Basic accuracy of Z (± % rdg.) B is the coefficient for the impedance of the sample	0.001 Hz (40 Hz) to 200 kHz Bottom A: Basic accuracy of θ (± % deg.) B is the coefficient for the impedance of the sample
---	---	--

Range	Guaranteed accuracy range	DC	IM3523		IM3533		IM3533-01	
			40.000 Hz to 99.9999 Hz	100.00 Hz to 999.99 Hz	1.0000 kHz to 10.000 kHz	10.001 kHz to 100.00 kHz	100.01 kHz to 200.00 kHz	
100 MΩ	8 MΩ to 200 MΩ	A=1 B=1	A=6 B=5 A=5 B=3	A=3 B=2 A=2 B=2	A=3 B=2 A=2 B=2			
10 MΩ	800 kΩ to 100 MΩ	A=0.5 B=0.3	A=0.8 B=1 A=0.8 B=0.5	A=0.5 B=0.3 A=0.4 B=0.2	A=0.5 B=0.3 A=0.4 B=0.2	A=3 B=2 A=2 B=2		
1 MΩ	80 kΩ to 10 MΩ	A=0.2 B=0.1	A=0.4 B=0.08 A=0.3 B=0.08	A=0.3 B=0.05 A=0.2 B=0.02	A=0.3 B=0.05 A=0.2 B=0.02	A=0.7 B=0.08 A=1.3 B=0.08	A=1 B=0.5 A=3 B=0.5	
100 kΩ	8 kΩ to 1 MΩ	A=0.1 B=0.01	A=0.3 B=0.03 A=0.3 B=0.02	A=0.2 B=0.03 A=0.1 B=0.02	A=0.15 B=0.02 A=0.1 B=0.015	A=0.25 B=0.04 A=0.4 B=0.02	A=0.4 B=0.3 A=1.2 B=0.3	
10 kΩ	800 Ω to 100 kΩ	A=0.1 B=0.01	A=0.3 B=0.025 A=0.3 B=0.02	A=0.2 B=0.025 A=0.1 B=0.02	A=0.05 B=0.02 A=0.03 B=0.02	A=0.2 B=0.025 A=0.4 B=0.02	A=0.3 B=0.03 A=0.6 B=0.05	
1 kΩ	80 Ω to 10 kΩ	A=0.1 B=0.01	A=0.3 B=0.02 A=0.2 B=0.02	A=0.2 B=0.02 A=0.1 B=0.02	A=0.15 B=0.02 A=0.08 B=0.02	A=0.2 B=0.02 A=0.4 B=0.02	A=0.3 B=0.02 A=0.6 B=0.02	
100 Ω	8 Ω to 100 Ω	A=0.1 B=0.02	A=0.4 B=0.02 A=0.2 B=0.01	A=0.3 B=0.02 A=0.15 B=0.01	A=0.15 B=0.02 A=0.1 B=0.01	A=0.2 B=0.02 A=0.4 B=0.02	A=0.3 B=0.03 A=0.6 B=0.02	
10 Ω	800 mΩ to 10 Ω	A=0.2 B=0.15	A=0.5 B=0.2 A=0.3 B=0.1	A=0.4 B=0.05 A=0.3 B=0.03	A=0.3 B=0.05 A=0.15 B=0.03	A=0.3 B=0.05 A=0.75 B=0.05	A=0.4 B=0.2 A=1.5 B=0.1	
1 Ω	80 mΩ to 1 Ω	A=0.3 B=0.3	A=2 B=1 A=1 B=0.6	A=0.6 B=0.3 A=0.5 B=0.2	A=0.4 B=0.3 A=0.25 B=0.2	A=0.4 B=0.3 A=1 B=0.2	A=1 B=1 A=2 B=0.5	
100 mΩ	10 mΩ to 100 mΩ	A=3 B=3	A=10 B=10 A=6 B=6	A=3 B=3 A=2 B=2	A=3 B=2 A=2 B=1.5	A=2 B=2 A=2 B=1.5	A=4 B=3 A=3 B=4	

Measurement Accuracy

Guaranteed accuracy range (measurement signal level)

The guaranteed accuracy range varies depending on the measurement frequency, measurement signal level, and measurement range.

Range	DC	IM3523	40.000 Hz to 99.9999 Hz	100.00 Hz to 999.99 Hz	1.0000 kHz to 10.000 kHz	10.001 kHz to 100.00 kHz	100.01 kHz to 200.00 kHz	
		IM3533	IM3533-01	0.001 Hz to 99.9999 Hz				
100 MΩ	2 V	0.101 V to 5 V						
10 MΩ		0.101 V to 5 V						
1 MΩ		0.050 V to 5 V				0.101 V to 5 V	0.501 V to 5 V	
100 kΩ		0.005 V to 5 V			0.005 V to 5 V		0.050 V to 5 V	0.101 V to 5 V
10 kΩ, 1 kΩ, 100 Ω		0.005 V to 5 V			0.005 V to 5 V		0.050 V to 5 V	0.101 V to 5 V
10 Ω		0.050 V to 5 V			0.050 V to 5 V			
1 Ω		0.101 V to 5 V (When DC bias: 1 V to 5 V)			0.101 V to 5 V (When DC bias: 1 V to 5 V)			
100 mΩ		0.501 V to 5 V (When DC bias: 0.501 V to 5 V)			0.501 V to 5 V (When DC bias: 0.501 V to 5 V)			

The above voltages are the voltage setting values corresponding to V mode or equivalent.

For the 10 MΩ to 1 kΩ range, when the measurement impedance value exceeds the range, the guaranteed accuracy range is as follows.

Range	DC	IM3523	40.000 Hz to 99.9999 Hz	100.00 Hz to 999.99 Hz	1.0000 kHz to 10.000 kHz	10.001 kHz to 100.00 kHz	100.01 kHz to 200.00 kHz	
		IM3533	IM3533-01	0.001 Hz to 99.9999 Hz				
10 MΩ	2 V	0.101 V to 5 V						
1 MΩ		0.101 V to 5 V						
100 kΩ		0.050 V to 5 V				0.101 V to 5 V	0.501 V to 5 V	
10 kΩ		0.005 V to 5 V			0.005 V to 5 V		0.005 V to 5 V	0.101 V to 5 V
1 kΩ		0.005 V to 5 V			0.005 V to 5 V		0.005 V to 5 V	0.101 V to 5 V

The above voltages are the voltage setting values corresponding to V mode or equivalent.

Method for determining basic accuracy

- Calculate the basic accuracy from the sample impedance, measurement range, measurement frequency, and corresponding basic accuracy A and coefficient B from the table on page 12.
- The calculation expression to use differs for each of the 1 kΩ range and above and 100 Ω range and below.
- For C and L, obtain basic accuracy A and coefficient B by determining the measurement range from the actual measurement value of impedance or the approximate impedance value calculated with the following expression.

$$Z_x (\Omega) \approx \omega L (H) \quad (\theta \approx 90^\circ)$$

$$\approx \frac{1}{\omega C (F)} \quad (\theta \approx -90^\circ)$$

$$\approx R (\Omega) \quad (\theta \approx 0^\circ) \quad (\omega: 2 \times \pi \times \text{Measurement frequency [Hz]})$$

Calculation example 1 (Basic accuracy of impedance Z)

Impedance Z_x of sample: 500 Ω (actual measurement value)
 Measurement conditions: When frequency 10 kHz and range 1 kΩ

Basic accuracy can be calculated on a PC

The bundled application software can be used to calculate the basic accuracy. Just enter the measurement conditions and measurement result and the measurement accuracy will be displayed. The application software allows you to easily evaluate the accuracy for the measurement value.

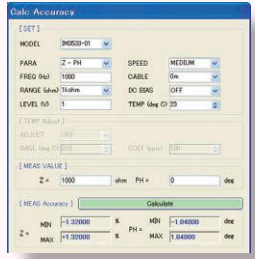

Application screen

Insert coefficient A = 0.15 and coefficient B = 0.02 for the Z basic accuracy from the table on page 12.

$$Z \text{ basic accuracy} = 0.15 + 0.02 \times \left| \frac{10 \times 500}{10^3} - 1 \right| = 0.23 (\pm \% \text{ rdg.})$$

Similarly, insert coefficient A = 0.08 and coefficient B = 0.02 for the θ basic accuracy, as follows:

$$\theta \text{ basic accuracy} = 0.08 + 0.02 \times \left| \frac{10 \times 500}{10^3} - 1 \right| = 0.16 (\pm \%)$$

Calculation example 2 (Basic accuracy of capacitor Cs = 160 nF)

- (1) Measure Z and θ of the sample with measurement range AUTO.
- (2) Suppose you have obtained the following Z and θ measurement values.
 Z = 1.0144 kΩ, θ = -78.69 °
 As Z is 1.0144 kΩ, the range is 10 kΩ.
- (3) For the 1 kHz and 10 kΩ range, insert coefficient A = 0.05 and coefficient B = 0.02 for the Z basic accuracy from the table on page 12.

$$Z \text{ basic accuracy} = \pm \left(0.05 + 0.02 \times \left| \frac{10 \times 1.0144 \times 10^3}{10 \times 10^3} - 1 \right| \right) \approx 0.05 (\pm \%)$$

Insert coefficient A = 0.03 and coefficient B = 0.02 for the θ basic accuracy.

$$\theta \text{ basic accuracy} = \pm \left(0.03 + 0.02 \times \left| \frac{10 \times 1.0144 \times 10^3}{10 \times 10^3} - 1 \right| \right) \approx 0.03 (\pm \%)$$

- (4) Determine the ranges for the Z and θ basic accuracy.

$$Z_{\min} = 1.0144 \text{ k}\Omega \times (1 - 0.05 / 100) = 1.01389 \text{ k}\Omega$$

$$Z_{\max} = 1.0144 \text{ k}\Omega \times (1 + 0.05 / 100) = 1.01490 \text{ k}\Omega$$

$$\theta_{\min} = -78.69 - 0.03 = -78.72^\circ$$

$$\theta_{\max} = -78.69 + 0.03 = -78.66^\circ$$

- (5) Determine the range for Cs from the Z and θ ranges.









$$C_{s \min} = 1 / (Z_{\max} \times \omega \times \sin(\theta_{\min})) \approx 159.907 \text{ nF} \dots\dots -0.06\%$$

$$C_{s \max} = 1 / (Z_{\min} \times \omega \times \sin(\theta_{\max})) \approx 160.100 \text{ nF} \dots\dots +0.06\%$$

Specifications

	IM3523	IM3533	IM3533-01
Measurement modes	LCR mode: Measurement with single condition Continuous measurement mode: Continuous measurement under saved conditions (maximum 2 sets)	LCR mode: Measurement with single condition Transformer measurement mode: N, M, ΔL Continuous measurement mode: Continuous measurement under saved conditions LCR mode (maximum 60 sets)	LCR mode: Measurement with single condition Transformer measurement mode: N, M, ΔL Continuous measurement mode: Continuous measurement under saved conditions LCR mode (maximum 60 sets) Analyzer mode (maximum 2 sets) Analyzer mode: Sweep with measurement frequency (Measurement points: 2 to 801) Sweep method: normal sweep Display: List display)
Measurement parameters	Z, Y, θ, Rs(ESR), Rp, Rdc(DC resistance), X, G, B, Cs, Cp, Ls, Lp, D(tanδ), Q	Z, Y, θ, Rs(ESR), Rp, Rdc(DC resistance), X, G, B, Cs, Cp, Ls, Lp, D(tanδ), Q, N, M, ΔL, T	
Measurement range	100 mΩ to 100 MΩ, 10 ranges (All parameters are determined according to Z)		
Display range	Z, Y, Rs, Rp, Rdc, X, G, B, Ls, Lp, Cs, Cp : ±(0.00000 [unit] to 9.99999 G [unit]) Absolute value display for Z and Y only θ: ±(0.000° to 180.000°), D : ±(0.00000 to 9.99999), Q : ±(0.00 to 9999.99), Δ% : ±(0.000% to 999.999%)		
Basic accuracy	T : -10.0 to +99.9 °C Z : ±0.05%rdg. θ: ±0.03°		
Measurement frequency	40 Hz to 200 kHz (5 digits setting resolution)	1 MHz to 200 kHz (5 digits setting resolution, minimum resolution 1 mHz)	
Measurement signal level	Normal mode: V mode/CV mode: 5 mV to 5 Vrms, 1 mVrms steps CC mode: 10 μA to 50 mArms, 10 μArms steps	Normal mode: V mode/CV mode: 5 mV to 5 Vrms, 1 mVrms steps CC mode: 10 μA to 50 mArms, 10 μArms steps Low impedance high accuracy mode: V mode/CV mode: 5 mV to 2.5 Vrms, 1 mVrms steps CC mode: 10 μA to 100 mArms, 10 μArms steps	
Output impedance	Normal mode: 100 Ω	Normal mode: 100 Ω, Low impedance high accuracy mode: 25 Ω	
Display	Monochrome LCD	5.7-inch color TFT, display can be set to ON/OFF	
Number of display digits setting	The number of display digits can be set from 3 to 6 (initial value: 6 digits)		
Measurement time	2 ms (1 kHz, FAST, display OFF, representative value)		
Measurement speed	FAST/MED/SLOW/SLOW2		
DC bias measurement	—	Normal mode: -5.00 V to 5.00 V (10 mV steps) Low impedance high accuracy mode: -2.50 V to 2.50 V (10 mV steps)	
DC resistance measurement	Measurement signal level: Fixed to 2 V	Measurement signal level: Fixed to 2 V Temperature compensation function: Converted reference temperature is displayed Reference temperature setting range: -10°C to 99.9°C Temperature coefficient setting range: -99,999 ppm/°C to 99,999 ppm/°C	
Comparator	LCR mode: Hi/IN/Lo for first and third items		
BIN measurement	10 main parameter categories, 1 sub-parameter category, and out of range	10 categories and out of range for 2 items	
Compensation	Open/short/load/correlation compensation Cable length: 0 and 1 m (accuracy is guaranteed for up to 4 m)	Open/short/load/correlation compensation Cable length: 0, 1, 2, 4 m	
Residual charge protection function	$V = \sqrt{10/C}$ (C: Capacitance [F] of test sample, V = max. 400 V)		
Trigger synchronous output function	Applies a measurement signal during analog measurement only		
Averaging	1 to 256		
Panel loading/saving	LCR mode: 60; Analyzer mode: 2; Compensation value: 128		
Memory function	Stores 32,000 data items to the memory of the instrument		
Interfaces	EXT I/O (handler), USB (Hi-Speed) Option: Any one of RS-232C, GP-IB, and LAN (10BASE-T/100BASE-TX) can be selected	EXT I/O (handler), USB (Hi-Speed), USB flash drive Option: Any one of RS-232C, GP-IB, and LAN (10BASE-T/100BASE-TX) can be selected	
Operating temperature and humidity ranges	0 °C (32 °F) to 40 °C (104 °F) , 80% rh or less, no condensation		
Storage temperature and humidity ranges	-10°C (14°F) to 50 °C (122°F) , 80% rh or less, no condensation		
Power supply	AC 100 to 240 V, 50/60 Hz, 50 VA max.		
Dimensions and mass	Approx. 260 mm (10.24 in) W × 88 mm (3.46 in) H × 203 mm (7.99 in) D, approx. 2.4 kg (84.7 oz)	Approx. 330 mm (12.99 in) W × 119 mm (4.69 in) H × 168 mm (6.61 in) D, approx. 3.1 kg (109.3 oz)	
Accessories	Power Cord ×1, Instruction Manual ×1, CD-R (Communication Instruction Manual and Sample Software) ×1		
Applicable standards	EMC: EN61326-1, Safety standard: EN61010		

■ LCR Meter Series Full Product Lineup

Model	Measurement speed (Basic value)		Measurement frequency range											
	Applications and measurement object													
LCR METER IM3536		1 ms	DC	4 Hz									8 MHz	General-purpose LCR meter up to 8 MHz Measure electronic components such as capacitors and inductors
LCR METER IM3533		2 ms	DC	1 mHz									200 kHz	Capable of special measurements of transformers including turn ratio and mutual inductance IM3533-01: High-end model of the IM3523 and IM3533 with sweep measurement
	IM3533 IM3533-01													
LCR METER IM3523		2 ms	DC	40 Hz									200 kHz	Extremely cost-effective model suitable for production lines including integration into automated machinery For C-D and ESR measurement of electrolytic capacitors and L-Q and Rdc measurement of inductors
LCR HiTESTER 3511-50		5 ms		120 Hz	1 kHz								Compact LCR meter with single function For production lines of aluminum electrolytic capacitors	
C METER 3506-10		1.5ms					1 kHz					1 MHz	C meter for low-capacity capacitors For production of MLCC and film capacitors	
C HiTESTER 3504		2 ms					120 Hz	1 kHz						C meter for large-capacity MLCCs For sorting machines of large-capacity MLCCs (3504-50/60) and taping machines (3504-40)
	3504-40 3504-50 3504-60													
IMPEDANCE ANALYZER IM7580A		0.5 ms										1 MHz	300 MHz	High-frequency measurement up to 300 MHz Ideal for production lines of ferrite beads and inductors
IMPEDANCE ANALYZER IM3570		0.5 ms	DC	4 Hz									5 MHz	LCR meter integrated with impedance analyzer Measure the frequency characteristics of piezo-electric devices, functional polymer capacitors, and power inductors
CHEMICAL IMPEDANCE ANALYZER IM3590		2 ms	DC	1 mHz									200 kHz	Supports LCR impedance measurements for Cole-Cole plots and equivalent-circuit analyses Measure electrochemical components, materials, batteries, and electric double-layer capacitors (EDLCs)

IM3523



IM3533, IM3533-01



Model : LCR METER IM3523

Model No. (Order Code) (Note)
IM3523 —

Model : LCR METER IM3533

Model No. (Order Code) (Note)
IM3533 —
IM3533-01 (added more functional model)

This product is not supplied with measurement probes or test fixtures. Please select and purchase the measurement probe or test fixture options appropriate for your application separately. All probes are constructed with a 1.5D-2 V coaxial cable. For an RS-232C connection: A crossover cable for interconnection can be used. You can use the RS-232C CABLE 9637 without hardware flow control.

Options

INTERFACE UNIT



GP-IB INTERFACE Z3000



RS-232C INTERFACE Z3001



LAN INTERFACE Z3002



GP-IB CONNECTION CABLE 9151-02
 2 m (6.56 ft)

• **RS-232C cable**

For RS-232C cable, a **crossover cable for interconnection can be used.**

(For details on connection, refer to page 10)

The 9637 RS-232C cable (9-pin to 9-pin, crossed cable) cannot be used for applications involving the flow control of hardware.

DC Bias Unit



DC BIAS VOLTAGE UNIT 9268-10

Direct connection type, 40 Hz to 8 MHz, maximum applied voltage of DC ±40 V.



DC BIAS CURRENT UNIT 9269-10

Direct connection type, 40 Hz to 2 MHz, maximum applied current of DC 2 A (maximum applied voltage of DC ±40 V). An internal 300 μH inductance is connected in parallel to the DUT.

When using the 9268-10 or 9269-10, external constant-voltage and constant-current sources are required.

TEMPERATURE PROBE



SHEATH TYPE TEMPERATURE PROBE 9478
 Pt100, tip ø2.3 mm (0.09 in), cord length 1 m (3.28 ft), water-proof structure

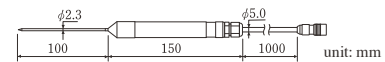

(Used for the temperature compensation function and only available for the IM3533 and IM3533-01)

Probes and Test Fixtures for Lead Components



FOUR-TERMINAL PROBE L2000

Cable length 1 m (3.28 ft), DC to 8 MHz, characteristic impedance of 50 Ω, 4-terminal pair design, measurable conductor diameter: 0.3 to 5 mm (0.01 to 0.20 in)



TEST FIXTURE 9261-10

Cable length 1 m (3.28 ft), DC to 8 MHz, characteristic impedance of 50 Ω, 4-terminal pair design, measurable conductor diameter: 0.3 to 1.5 mm (0.01 to 0.06 in)



FOUR-TERMINAL PROBE 9140-10

Cable length 1 m (3.28 ft), DC to 200 kHz, characteristic impedance of 50 Ω, 4-terminal pair design, measurable conductor diameter: 0.3 to 5 mm (0.01 to 0.20 in)



TEST FIXTURE 9262

Direct connection type, DC to 8 MHz, measurable conductor diameter: 0.3 to 2 mm (0.01 to 0.08 in)

Test Fixtures for SMDs



SMD TEST FIXTURE IM9110

Measurable range: DC to 1 MHz, For SMD with electrodes on side, Measurable sample sizes: 008004 (EIA), 0201 (JIS), Please contact Hioki for information about other sizes, Direct connection type



SMD TEST FIXTURE IM9100

Measurable range: DC to 8 MHz, For SMD with electrodes on bottom, Measurable sample sizes: 01005 to 0402 (EIA) 0402 to 1005 (JIS), Direct connection type



SMD TEST FIXTURE 9677

Direct connection type, for SMDs with electrodes on the side, DC to 120 MHz, SMD sizes: 3.5 ±0.5 mm



PINCHER PROBE L2001
 Ships standard with one set of IM9901

Cable length 730 mm (2.40 ft), DC to 8 MHz, characteristic impedance of 50 Ω, 4-terminal pair design, 2-terminal electrode, tip electrode spacing of 0.3 to approx. 6 mm (0.01 to approx. 0.24 in)

Options for L2001
 Replaceable contact tips



CONTACT TIPS IM9901
 Compatible chip sizes: 1608 to 5750 (JIS)



CONTACT TIPS IM9902
 Compatible chip sizes: 0603 to 5750 (JIS)



SMD TEST FIXTURE 9699

Direct connection type, for SMDs with electrode on the bottom, DC to 120 MHz, SMD sizes: 1.0 to 4.0 mm wide, 1.5 mm or less high



SMD TEST FIXTURE 9263

Direct connection type, DC to 8 MHz, SMD sizes: 1 to 10 mm (0.04 to 0.39 in)

For Electrochemical Measurement



FOUR-TERMINAL PROBE 9500-10

Cable length 1 m (3.28 ft), DC to 200 kHz, impedance characteristics of 50 Ω, 4-terminal pair configuration, measurable conductor diameter: ø0.3 mm (0.01 in) to 2 mm (0.08 in)

Note: Company names and product names appearing in this brochure are trademarks or registered trademarks of various companies.

HIOKI
 HIOKI E. E. CORPORATION

DISTRIBUTED BY

HEADQUARTERS
 81 Koizumi,
 Ueda, Nagano 386-1192 Japan
<https://www.hioki.com/>



Scan for all regional contact information