

HIOKI

POWER ANALYZER PW8001

Highest Accuracy.
Largest Number of Channels.
Maximum Flexibility.



Featuring power spectrum analysis (PSA), providing powerful capability for analyzing high-frequency power loss

New in firmware Version 2



Ver. 2

Providing the ultimate power analyzer for use by all engineers pursuing power conversion efficiency

1 World-class measurement accuracy

**Basic accuracy $\pm 0.03\%$, DC accuracy $\pm 0.05\%$, 50 kHz accuracy $0.2\%^*$
 Frequency flatness: band where amplitude falls within $\pm 0.1\%$ range: **300 kHz***
 band where phase falls within $\pm 0.1^\circ$ range: **500 kHz*****

Evaluating power conversion efficiency requires the ability to accurately measure power in every band, from DC to high frequencies. The PW8001 delivers exceptional measurement accuracy not only for 50/60 Hz, but also across a broad frequency band, including for DC and at 50 kHz. This allows it to accurately evaluate power conversion efficiency which often involves measuring multiple frequencies.

2 Accurate capture of power fluctuations caused by high-speed switching

Sampling performance 18-bit, 15 MHz*
Noise Resistance (CMRR) 110 dB, 100 kHz*

Sampling performance and noise resistance is important for evaluating power converters that use materials like SiC and GaN due to the power fluctuations caused by their high-speed switching. The PW8001 can accurately capture high-speed switching waveforms thanks to its high sampling performance and noise resistance.

3 Up to 8 power channels optimizing your measurement

8-channel power measurement

Increasingly, hardware like electric vehicle (EV) drive systems that use dual inverters and electric power interchange systems in smart homes are adopting multi-circuit designs in order to utilize energy effectively. A single PW8001 can measure 8 channels of power data, allowing equipment with 8 measurement points for power such as dual motors as well as other equipment with multiple circuits to be evaluated in one stroke.



*Typical value when using the U7005.

1 World-class measurement accuracy

Power accuracy at various frequencies

PW8001+U7005
PW8001+U7001

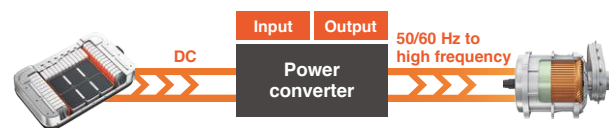
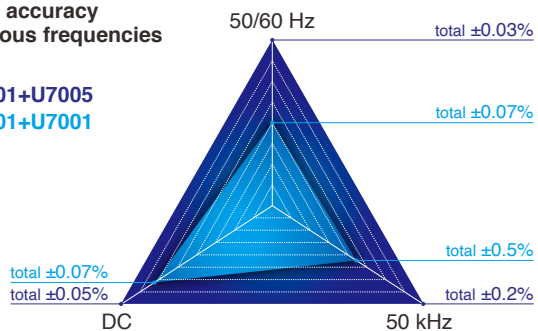

Accuracy in all bands, from DC to high frequencies, is important

Example of active power-frequency characteristics

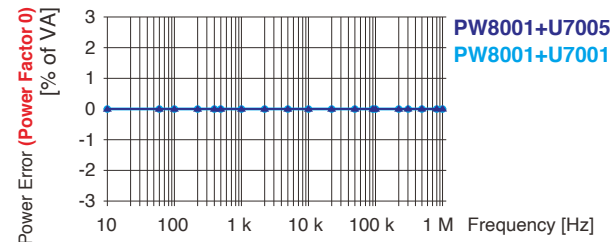
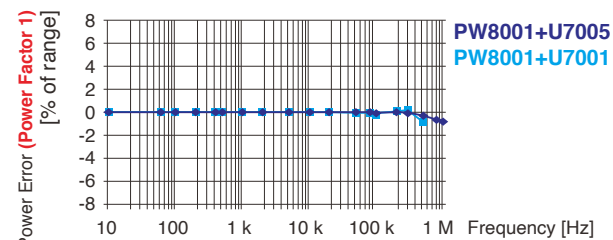

The PW8001 measures even high-frequency and low-power-factor power with a high degree of accuracy

2 Accurate capture of power fluctuations caused by high-speed switching

Use of two key components (by the U7005) allows the instrument to deliver both exceptional sampling performance and noise resistance

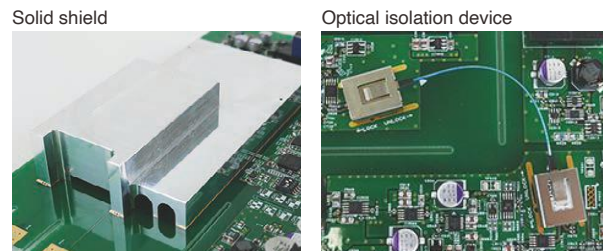

Model	Sampling performance	
	Frequency	Resolution
PW8001 +U7005	15 MHz	18-bit
PW8001 +U7001	2.5 MHz	16-bit

Common-mode voltage rejection ratio for voltage input

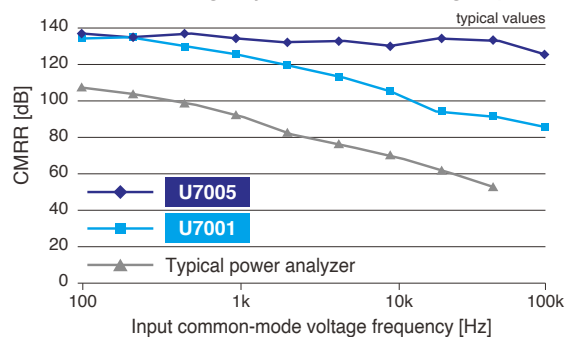

3 Up to 8 power channels optimizing your measurement

- 8-channel power measurement
- Install up to 8 input modules, freely combined from 2 different module types

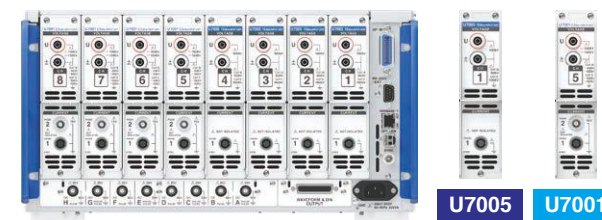

EV dual inverter

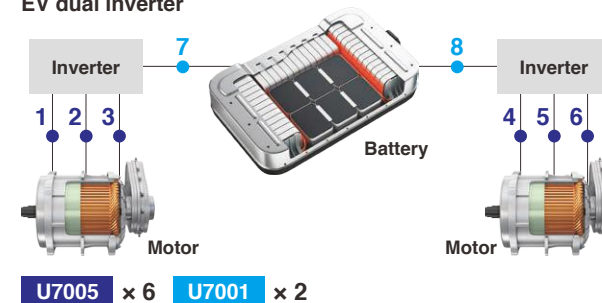

Power interchange system

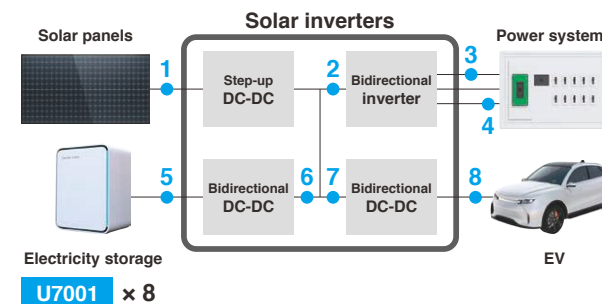

Full-featured compatibility with current sensors

Current sensing has a substantial impact on power measurement accuracy as well as work efficiency. Hioki designs and develops its current sensors in-house for maximum compatibility with power analyzers and advanced power measurement capability.

1 Get started making measurements right away

Standard current sensor power supply and recognition functionality

The PW8001 supplies power to current sensors and automatically sets the appropriate scaling ratio for each. Simply connect sensors and get started making measurements.

2 Accurately measure high-frequency, low-power-factor power

Current sensor automatic phase correction function*

Correcting phase error is important in order to accurately measure high-frequency, low-power-factor power. The PW8001 automatically acquires each current sensor's phase characteristics and performs phase correction with a resolution of 0.001°. As a result, the instrument is able to realize current sensors' full performance without requiring a troublesome configuration process.

3 Record measurement conditions

Automatic acquisition of current sensor information*

When you connect a current sensor to the PW8001, the instrument automatically acquires its model and serial number. Detailed measurement conditions can be recorded along with measurement data.

4 Extensive product line



*When used with a current sensor with automatic phase correction functionality (see page 31 for details).

- 1 Get started making measurements right away
- 2 Accurately measure high-frequency, low-power-factor power
- 3 Record measurement conditions

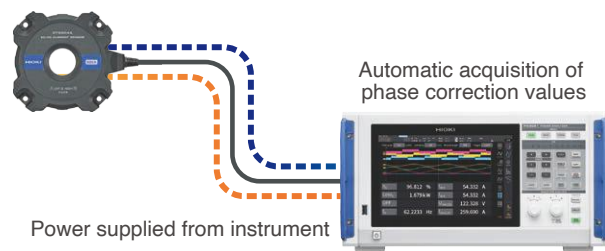

Information stored in the current sensors' internal memory

Phase shift	Rated current
Sensor model	Serial number

Example of the automatic phase correction for the CT6904A AC/DC current sensor

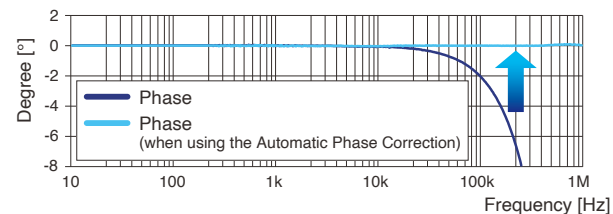

At low power factors, phase error has a substantial impact on power error

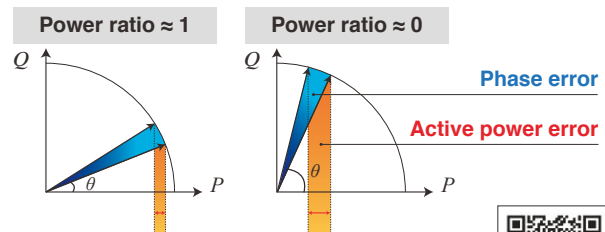

Technical documentation on phase correction is available.



4 Extensive product line

EV inverter system R&D
Evaluation of reactor and transformer loss



Pass-through sensors offer the ultimate level of accuracy, frequency band, and stability. Broadband measurement of up to 10 MHz and the ability to measure large currents of up to 2000 A make these sensors ideal for use in state-of-the-art R&D.

WLTP-compliant fuel economy
(electricity cost) performance testing



This clamp-style sensor lets you quickly and easily connect the instrument for measurement. It's used in testing of assembled vehicles where it would be difficult to cut wires. Capable of withstanding temperatures of -40°C to 85°C, the device can be used in the hot environment of an engine compartment.

Evaluation of reactor and transformer loss
Evaluation of inverters in energy-saving household appliances



Our proprietary DCCT method allows our 50 A direct-wired sensor to deliver world-class accuracy and bandwidth.

Are you making measurements under conditions that approach the actual operating environment?

Broadly speaking, there are two ways to detect current: **the current sensor method** and the direct wiring method. Current sensors let you evaluate equipment accurately under wiring conditions that approach the actual operating environment.

Measurement example using the current sensor method

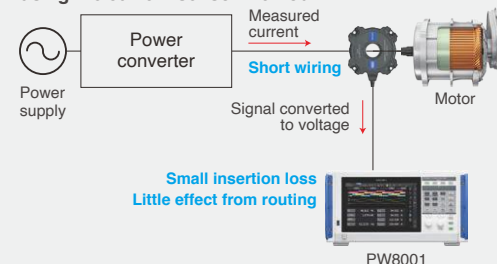

A current sensor is connected to the measurement target. This reduces the effects of wiring and loss on the side of the measurement instrument. This allows measurements with wiring conditions that are close to the actual operating environment of a highly efficient system.

Measurement example using the direct wiring method

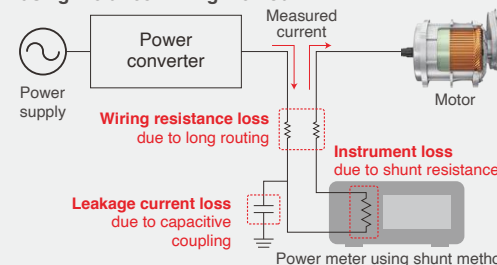

The wiring of the measurement target is routed for connecting to the current input terminal. However, this results in an increase in the influence of power loss from wiring resistance and capacitive coupling, and meter loss due to shunt resistance. All of this loss leads to larger degradation in accuracy.



View technical articles on power measurement in the development of EV motors and inverters.



Measurement solutions for EVs

Detecting power fluctuations during vehicle operation

1 Reliably detect high-speed power fluctuations

1 ms data refresh

When evaluating battery charging/discharging or torque response as part of road testing, engineers need to accurately measure and analyze a vehicle's operating conditions without missing anything. Thanks to its high-speed calculation capability, the PW8001 updates data in as fast as 1 ms without affecting the measurement accuracy*1 due to fast calculations. Power and power behavior under transient conditions can be analyzed in high definition.

2 Continuously detect power conversion efficiency and loss

Automatic equation selection in AUTO mode

In AUTO mode, the PW8001 switches between equations automatically depending on power polarity. As a result, the instrument can track the fluctuating flow of energy across charging/discharging and power-operation/regeneration driving states, allowing efficiency and loss to be measured continuously.

Visual energy flow display

The PW8001's efficiency and loss calculation screen can display four calculation results simultaneously. In addition, when using AUTO mode, the instrument displays energy flows using arrows so that they can be ascertained in real time.

3 Compensation of torque meter measurement error

Torque value correction functions*2

Torque meter measurement error has a substantial impact on motor analysis. The PW8001 can perform calculations using a correction table based on user-defined values for nonlinear compensation and friction compensation. The instrument can accurately analyze high-efficiency motors as well.

4 PMSM online parameter measurement

Electrical angle measurement function*2

In order to implement fine control of a permanent magnet synchronous motor (PMSM), it's necessary to assess the motor's characteristics under actual operating conditions. The PW8001's electrical angle measurement function can perform voltage and current advance measurement, which is necessary in order to implement vector control of the dq coordinate system.

User-defined calculations

The instrument can calculate user-defined equations combining measured values, functions, and constants in real time. Up to 20 equations, each consisting of up to 16 terms, can be defined. Used with the PW8001's electrical angle measurement function, this capability lets you measure motor parameters (Ld, Lq) during vehicle operation.



Technical documentation on how to measure PMSM parameters is available.

*1: Except when motor frequency input is used. *2: Models equipped with motor analysis function only.

1 Reliably detect high-speed power fluctuations

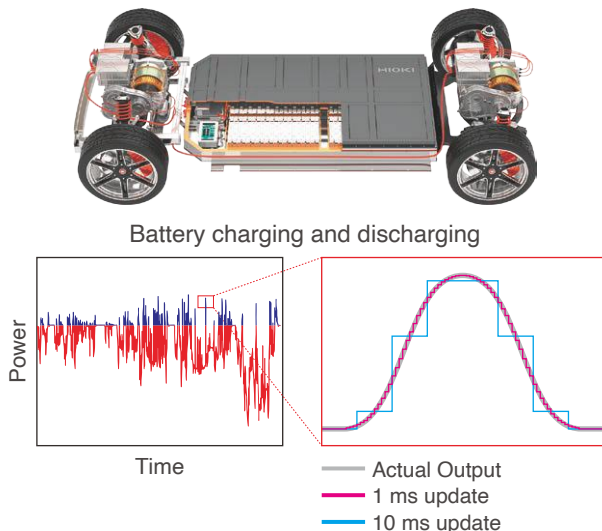

3 Compensation of torque meter measurement error

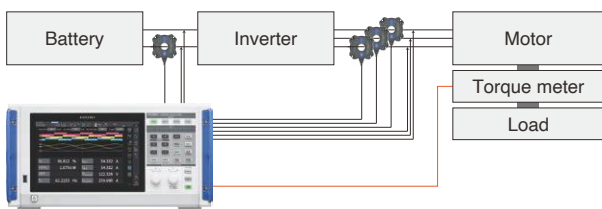

Compensate torque meter error using calculations based on a correction table

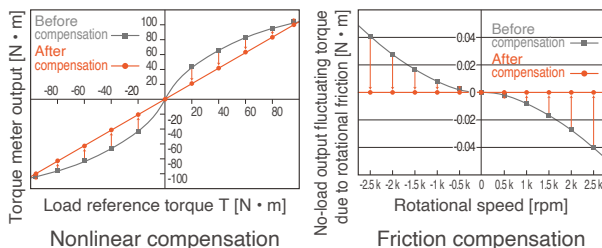

2 Continuously detect power conversion efficiency and loss

η : Power efficiency Loss: Power loss

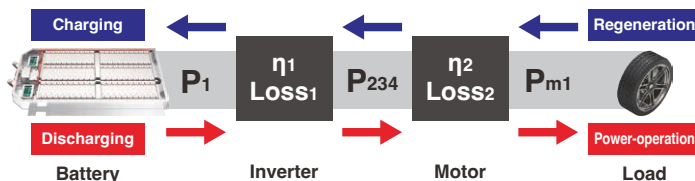

Auto mode	Inverter		Motor	
	η_1 [%]	Loss1 [W]	η_2 [%]	Loss2 [W]
Charging	IP11/IP234 x100	IP234I-IP1I	IP234I/IPm1 x100	IPm1I-IP234I
Regeneration	IP234I/IP1I x100	IP1I-IP234I	IPm1I/IP234 x100	IP234I-IPm1I

PW8001 detects charging/discharging and power-operation/regeneration driving states and switches equations automatically.

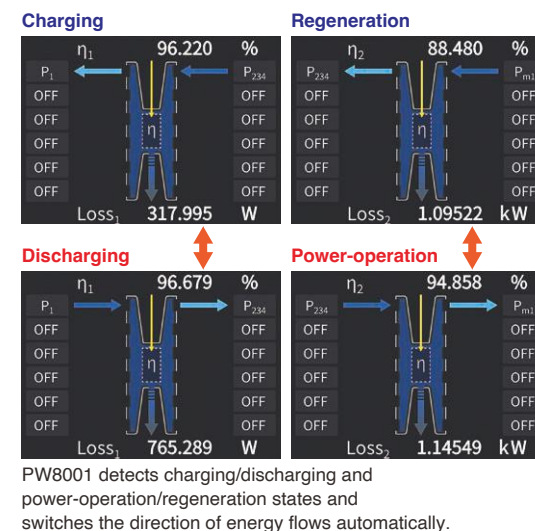

PW8001 detects charging/discharging and power-operation/regeneration states and switches the direction of energy flows automatically.

4 PMSM online parameter measurement

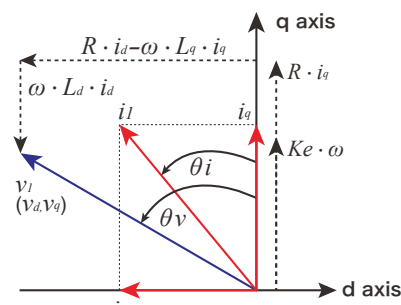

$$L_d = \frac{v_q - K_e \cdot \omega - R \cdot i_q}{\omega \cdot i_d} \quad L_q = \frac{R \cdot i_d - v_d}{\omega \cdot i_q}$$

L_d and L_q impedance values in the d - and q -axis directions are calculated based on the results of analyzing the d -axis and q -axis voltage and current vectors.

Example of user-defined calculations

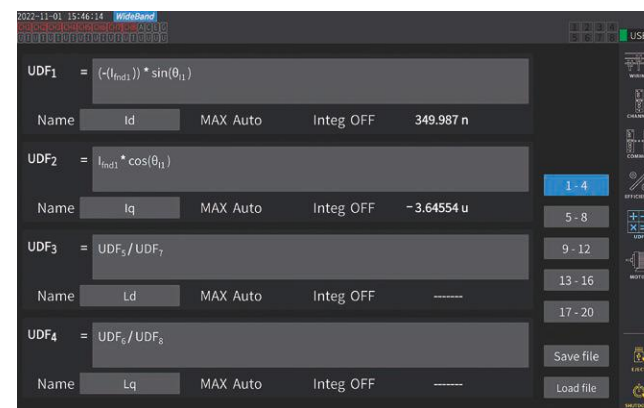

You can define up to 20 equations (with up to 16 terms each).



Measurement solutions for EVs

Comprehensive power analysis with simultaneous measurement and data integration



View technical documents on measuring inductor and transformer losses in power supplies for EVs.

Extend xEV driving range while realizing enhanced ride comfort

By building an energy-efficient system that controls the entire vehicle in a fine-grained manner, you can extend range while realizing enhanced ride comfort. When measuring power in order to evaluate an xEV system, **it's important to accurately detect high-speed power fluctuations and to capture data from throughout the system in an integrated manner.** The PW8001's measurement performance ensures power fluctuations can be accurately detected during vehicle operation. In addition, capabilities like simultaneous motor analysis and data output via CAN signals let you evaluate the entire system by integrating the status of individual components into a single data stream.

5 Simultaneous measurement of harmonics in multiple circuits at different frequencies

Simultaneous measurement of up to 500th-order harmonics in 8 circuits

The PW8001 can simultaneously measure harmonics that are synchronized to each circuit's frequency in up to 8 circuits, for example by measuring output from a multi-circuit inverter. Analysis results can be reviewed in the form of a harmonic bar graph, vector display, or list.

6 Simultaneous analysis of 4 motors

4-motor/2-motor simultaneous analysis function^{*1}

Given signal input from torque meters and tachometers, the PW8001 can simultaneously analyze 4 motors. This capability is ideal for evaluating systems that control wheels with multiple motors, for example electric AWD drivetrains. The instrument can also measure output from devices such as actinometers and anemometers.

7 Observation of analog signals, CAN signals, and power fluctuations on the same time series

Interoperation with the Memory HiLogger LR8450 and CAN Units U8555/LR8535^{*2}

You can record CAN or CAN FD signals from a vehicle, analog signals such as temperature and vibration data, and power data measured by the PW8001 as part of a single time series and observe that information over an extended period of time. This capability makes possible comprehensive evaluations based on vehicle conditions and power fluctuations.

8 Power control unit measurement and compliance

Accurate monitoring of power parameters and measurement parameter optimization with INCA^{*3}

Utilize INCA, the Hioki add-on, and the ES592IF module with the PW8001 and AC/DC current sensors. This setup allows you to efficiently perform PCU compliance tasks using accurate power and dynamic measurements, while simultaneously monitoring CAN bus data and ECU RAM values.

^{*1}: Models equipped with motor analysis function only.

^{*2}: Models equipped with CAN or CAN FD interface only.

^{*3}: A measurement compliance and diagnostic tool from ETAS.

1 Simultaneous measurement of harmonics in multiple circuits at different frequencies

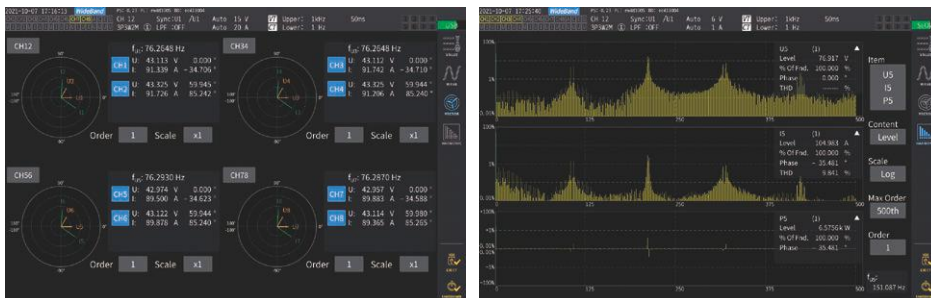

Example of 4-inverter-motor analysis with a 3P3W2M connection

Example of harmonic analysis of the 500th-order

U7001	Harmonic analysis up to 500th order	Basic frequency: 0.1 Hz to 1 MHz, Analyzable band: 1 MHz
U7005		Basic frequency: 0.1 Hz to 1.5 MHz, Analyzable band: 1.5 MHz

3 Observation of analog signals, CAN signals, and power fluctuations on the same time series

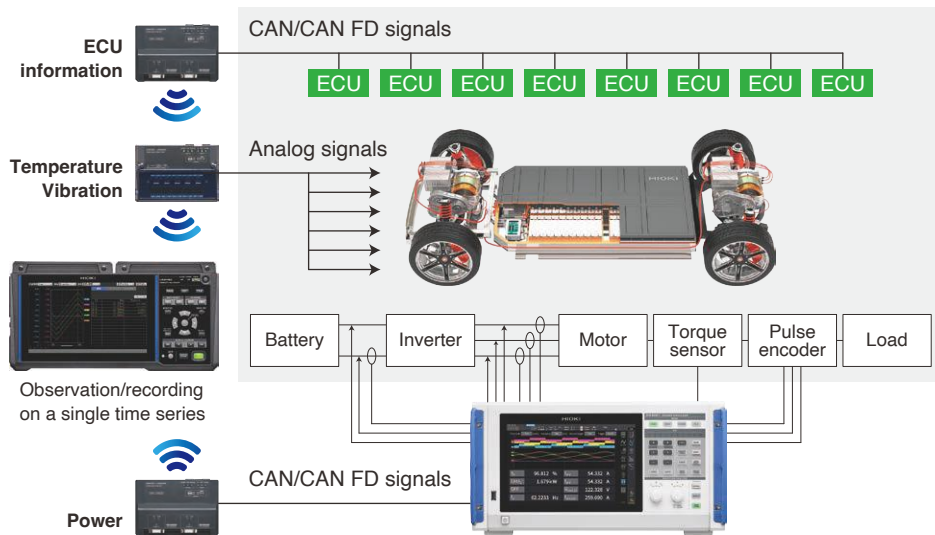

2 Simultaneous analysis of 4 motors

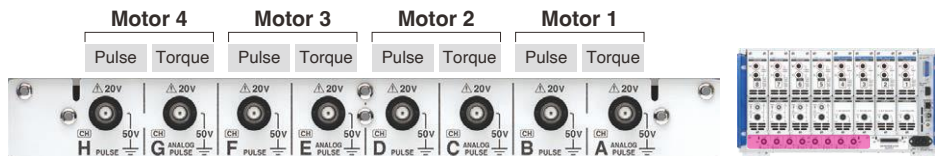

Mode	4-motor analysis	2-motor analysis	Independent input
Measurement target	4-motor	2-motor	Anemometer, pyranometer, other output, signals
Input	CH A/ CH E	Torque	Torque
	CH B/ CH F	RPM	Encoder's A phase signal
	CH C/ CH G	Torque	Encoder's B phase signal
	CH D/ CH H	RPM	Encoder's Z phase signal
Measurement parameters	Motor power	Electric angle	Voltage × 4
	Torque	Motor power	Frequency × 4
	RPM	Torque	or
	Slip	RPM	Frequency × 8

5 Observation of analog signals, CAN signals, and power fluctuations on the same time series

The combination of INCA and PW8001. Accelerates accurate measurement and optimization of PCU parameters.

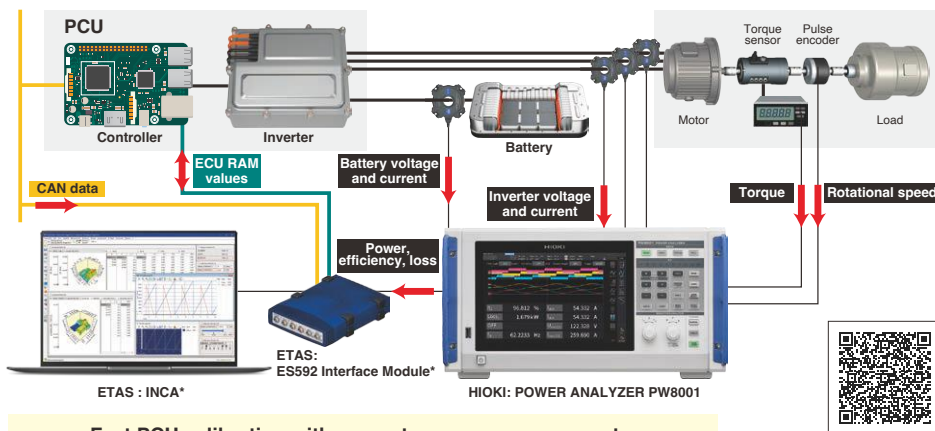

Fast PCU calibration with accurate power measurements. Simultaneously monitor CAN bus data and ECU RAM values.

*Please contact ETAS for more information about INCA, the Hioki add-on, and the ES592IF module.

Find out more about the INCA-HIOKI add-on. Data courtesy of ETAS.

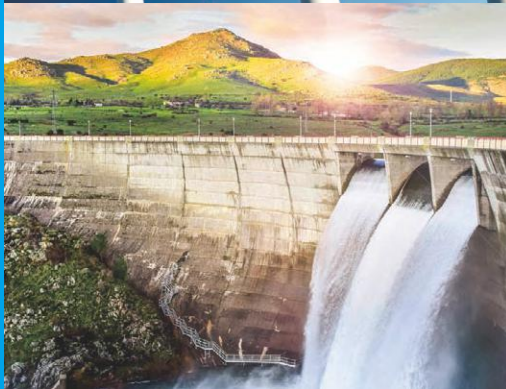

Measurement solutions for renewable energy

1 Safe evaluation of increasingly high-voltage power conditioners

1500 V DC CAT II, 1000 V DC CAT III*1

Renewable energy generation systems are being engineered to use increasingly high voltages in order to reduce equipment construction costs and transmission loss. Evaluating generation systems requires instruments that are capable of high-voltage measurement. The PW8001 Input Unit U7001 can safely measure directly input high voltages of up to 1500 V DC (CAT II) and 1000 V DC (CAT III). (The Voltage Cord L1025, which can accommodate 1500 V DC [CAT II] and 1000 V DC [CAT III], is also available.)

2 Analysis of power loss in reactors

High-accuracy measurement of high-frequency, low-power-factor power

In order to improve power conversion efficiency, it's necessary to assess power loss in reactors. The lower the reactor's loss, the lower the power factor, making accurate measurement difficult. The U7005's outstanding high-frequency characteristics and noise resistance make it an extremely effective tool for analyzing power loss in high-frequency, low-power-factor reactors.

3 Multi-string PCS evaluation

16-channel power measurement via the PW8001's optical link interface*2 **Ver. 2**

Manufacturers are pursuing multi-string PCS development to maximize the generating capacity of solar power systems. Multi-string PCS systems control operating points to create the maximum amount of power-per-string. Since such systems have more circuits, evaluation testing requires measurement of more points. Two PW8001 instruments can be connected via their optical link interface, enabling one instrument to aggregate data from both devices. Up to 16 channels of power data can be analyzed and efficiency/loss displayed and recorded on one instrument.

4 IEC standard compliant evaluation of grid interconnections

IEC standard compliant harmonic and flicker measurement **Ver. 2**

Grid interconnections allow power consumers to connect their generation equipment to the power company's power grid in order to purchase power as necessary and sell surplus power. As a result, power generated by consumer-operated systems must provide the same level of quality as power provided by the power company. The PW8001 can perform IEC 61000-4-7 standard-compliant harmonic measurement as well as IEC 61000-4-15 standard-compliant flicker measurement. IEC standard-compliant harmonic measurement capabilities include harmonic measurement up to the 200th order as well as intermediate harmonic measurement. The instrument can also be used in grid interconnections tests of many countries such as Germany's VDE-AR-N 4105 grid interconnect standard.

Ver. 2 This function was supported by a firmware update.

*1: U7001 only.

*2: Models equipped with the optical link interface only.

1 Safe evaluation of increasingly high-voltage power conditioners

Example of evaluation testing of solar inverters

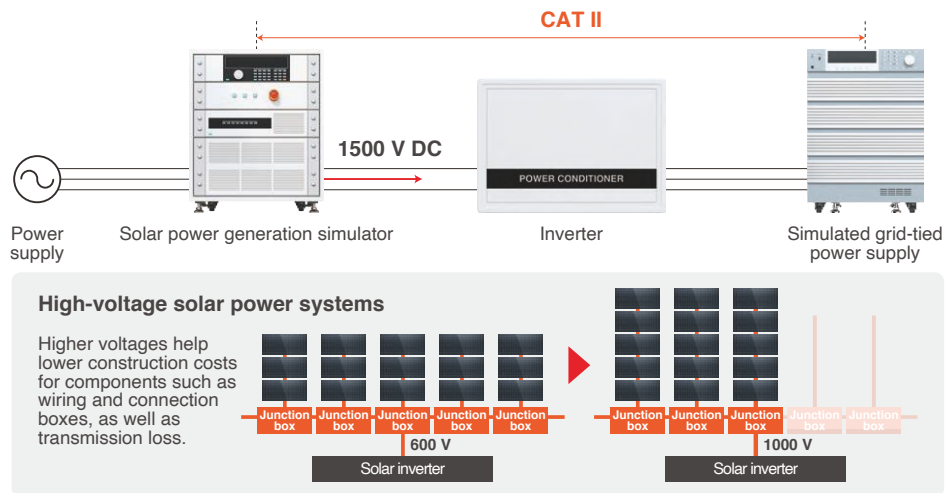

2 Analysis of power loss in reactors

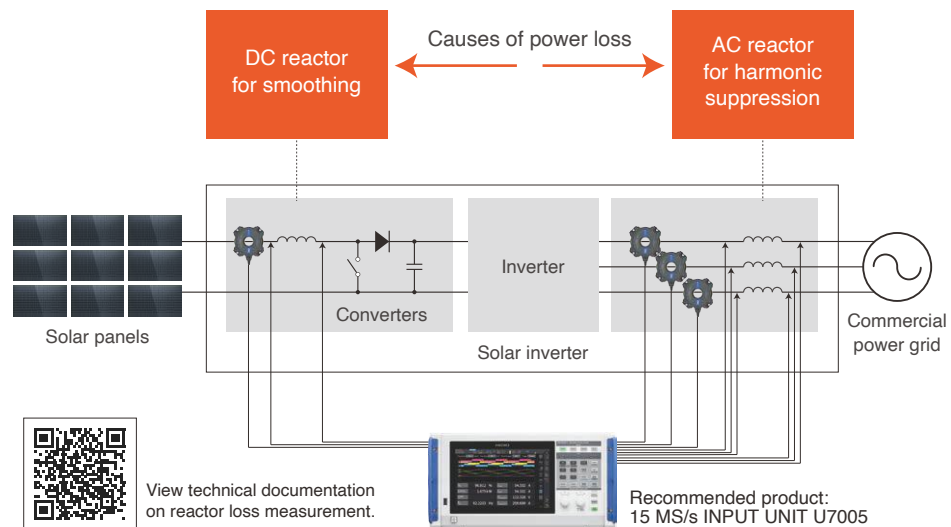

3 Multi-string PCS evaluation

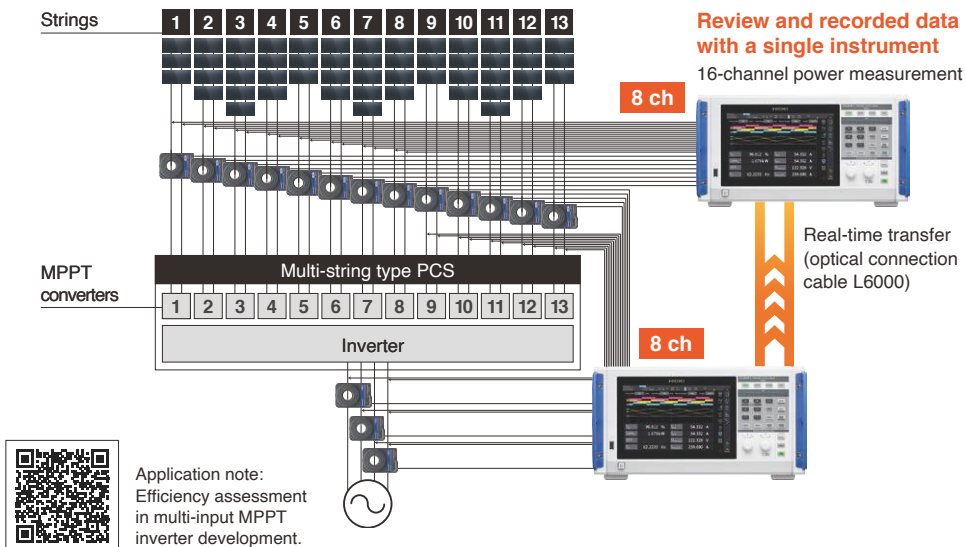

4 IEC standard compliant evaluation of grid interconnections

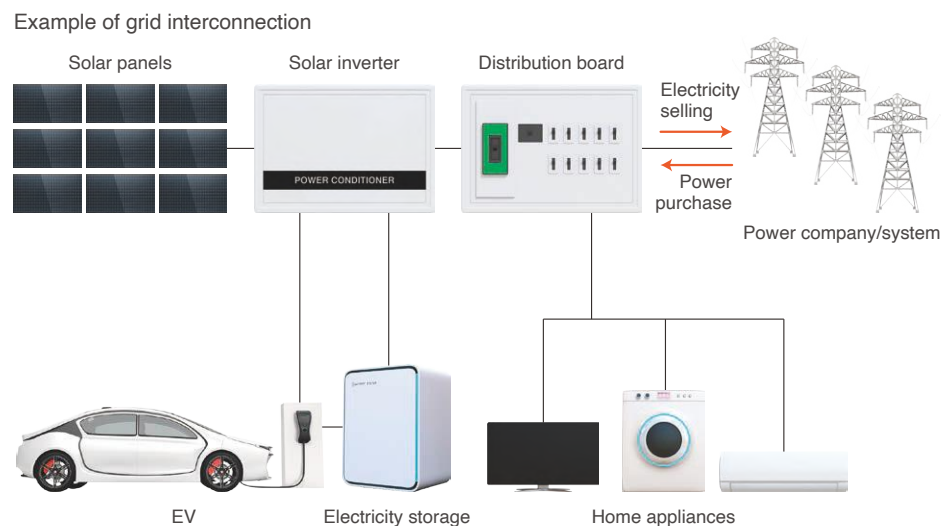



Seamlessly observe, record, and analyze.

Pioneering inverter innovation with advanced waveform analytics.

1 Observe waveforms in real time with waveform refresh speed on par with an oscilloscope

High-speed waveform display driven by a GPU-equipped power analysis engine

To accurately assess the state of devices such as inverters and motors that change from moment to moment, it's essential to observe instantaneous voltage and current waveforms in real time. The PW8001's Power Analysis Engine III, equipped with a graphics processing unit (GPU), refreshes the waveform display up to 40 times per second*. The ability to immediately ascertain device state contributes to efficient evaluation.

2 Capture target waveforms reliably with high-capacity storage

Event trigger function **Ver. 2**, pre-trigger function, and 5 Mpoint/Channel high-capacity storage

The PW8001 offers extensive trigger functionality, including waveform triggers and event triggers. You can capture intermittent phenomena reliably using trigger functionality that automatically starts waveform recording based on set conditions. Additionally, the pre-trigger function and high-capacity storage of 5 Mpoints per channel enable you to easily record waveforms before and after the trigger event.

3 Utilize extensive functionality for analyzing captured waveforms

Cursor measurement, zoom function **Ver. 2**

You can display selected waveforms and measured values from power spectrum analysis using cursor measurement. In addition, you can expand captured waveforms along the time axis with the zoom function and simultaneously generate a 2-axis display. You can also simultaneously observe how the selected momentary waveform changes while displaying waveforms covering extended periods of time.

4 Conduct detailed analyses of power conversion loss using power spectrum analysis (PSA)

Power spectrum analysis (PSA) function **Ver. 2**

With the PW8001's power spectrum analysis (PSA) function, you can gain important clues and trends concerning loss factors in power conversion. As use of SiC and GaN power semiconductors leads to higher switching frequencies, reducing power losses in the high-frequency domain has become a key development priority. By using the PSA function to make intuitive and quantitative assessments of high-frequency power, which cannot be observed using conventional harmonic analysis, you can obtain useful knowledge for inverter control design optimization and motor magnetic design.

Ver. 2 This function was supported by a firmware update.

* At a sampling rate of 15 MS/s and a recording length of 1 kpoint.

1 Observe waveforms in real time with waveform refresh speed on par with an oscilloscope

High-speed waveform display driven by a GPU-equipped power analysis engine

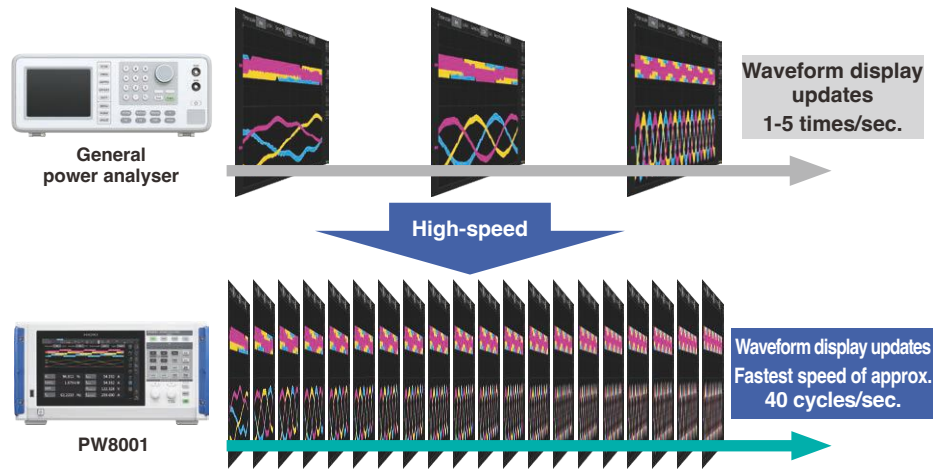

2 Capture target waveforms reliably with high-capacity storage

Event trigger function

Apply triggers using user-defined measurement parameters to capture the desired waveform.

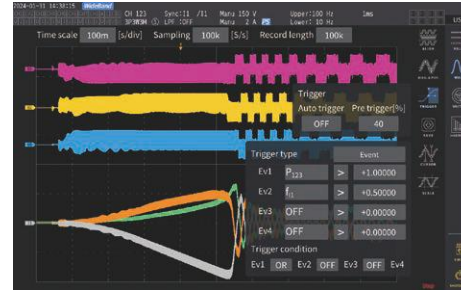

Reliable capture of intermittent phenomena

High-capacity waveform storage.

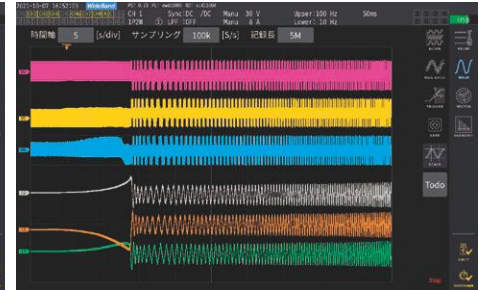

You can capture waveforms before and after the moment you wish to observe by applying triggers to fluctuating numerical data such as RMS values, frequencies, and torque values. Triggers can be set using complex conditions based on OR and AND operations.

Sampling recording length examples are 5 times those of Hioki's previous model (PW6001).

At 10 kS/s	500 sec.
At 100 kS/s	50 sec.

3 Utilize extensive functionality for analyzing captured waveforms

Cursor measurement



Using the cursor function, you can display measured values for selected waveforms and FFT results. Using the XY cursor function, you can display MAX, MIN, ΔU, I, and t values.

Zoom function

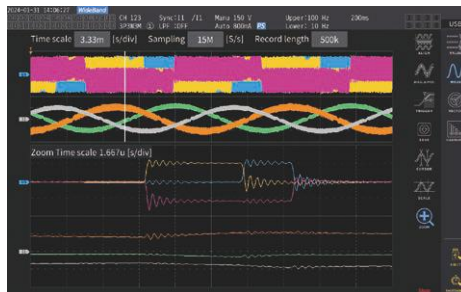

You can zoom in on captured waveforms along the time axis (with a zoom factor ranging from 2 to 1,000,000). Using the rotary knobs, you can intuitively specify the zoom factor and the position of the zoom region.

4 Conduct detailed analyses of power conversion loss using power spectrum analysis (PSA)

Intuitive and quantitative understanding of high-frequency power losses

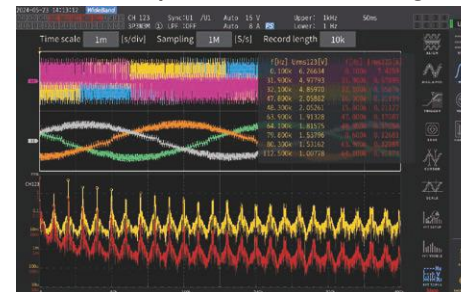

Conventional voltage and current FFT analysis FFT analysis of active power (up to 6 MHz)

Power Spectrum Analysis (PSA) applies FFT analysis to recorded waveforms of voltage, current, and active power, in real-time and up to a maximum of 6 MHz. And the instrument automatically compiles a "Top 10" list of peak components and displays a list of associated values. By combining a Hioki current sensor of excellent frequency characteristics with the PW8001's automatic phase correction technology, you can perform reliable verification work of up to high frequencies.



Video: Introducing the PSA Function for Best Investigating Loss Factors in Power Conversion



Application note: Investigation of Inverter Motor Loss Using the Power Spectrum Analysis (PSA) Function.

Accurate, reproducible measurement

The PW8001 can automatically adjust to a variety of equipment operating conditions to attain the optimal measurement. In addition, it provides highly reproducible measurement of inverter variable-speed control, making it possible to accurately assess the equipment's fluctuations.

Six types of "AUTO" measurement made possible by Power Analysis Engine III

AUTO 1 Appropriate range settings

Auto range

To acquire accurate measured values, it's necessary to set the range appropriately based on the magnitude of the input voltage and current. The PW8001 automatically switches to the optimal measurement range based on voltage and current input levels.

AUTO 2 Reliable current sensor phase correction

Auto phase correction

To acquire accurate measured values, it's important to perform current sensor phase correction. The PW8001 performs phase correction automatically; users need only connect the current sensors. (See page 4 for details.)

AUTO 3 Stable zero-cross detection

Auto zero-cross filter

To accurately detect zero-cross events, noise superposed on input signals is rejected using a filter. The PW8001 automatically varies the filter cutoff frequency based on the input signal's frequency. As a result, the instrument is able to detect zero-cross events for variable-speed equipment such as inverters that are used to drive motors.

AUTO 4,5 Anti-aliasing error-free harmonic analysis and power spectrum analysis

Auto antialiasing processing

To enhance accurate harmonic and power spectrum analysis, a filter is used to reject signals above the frequency band being analyzed. With the PW8001, the filter's cutoff frequency is automatically varied based on conditions such as the fluctuating frequency. As a result, the instrument delivers accurate harmonic analysis and power spectrum analysis, even for devices with fluctuating RPM and signal components that include high frequencies, for example inverters used to drive motors.

AUTO 6 Reliable detection of power fluctuations

Auto data update

The length of motors' frequency cycles fluctuates based on operating conditions, for example depending on whether the vehicle is starting from a stopped state or is accelerating. The PW8001 records data as frequently as every 1 ms and updates measured values based on the input signal cycle length. As a result, the instrument can reliably detect power fluctuations in equipment whose frequencies fluctuate, from low to high frequencies.

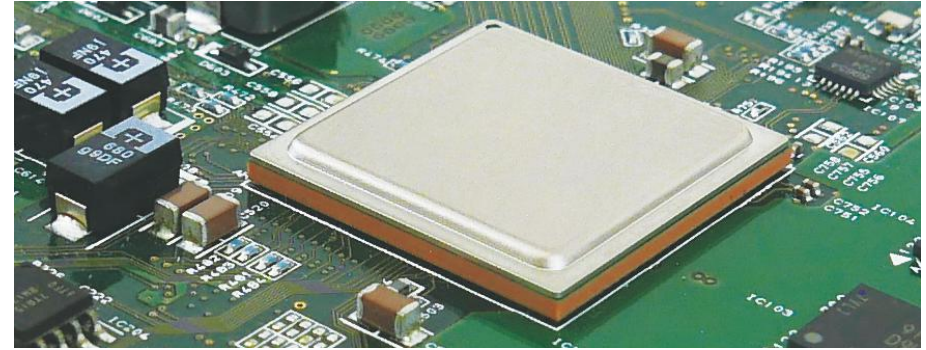

Illustration of simultaneous calculation processing by the Power Analysis Engine III

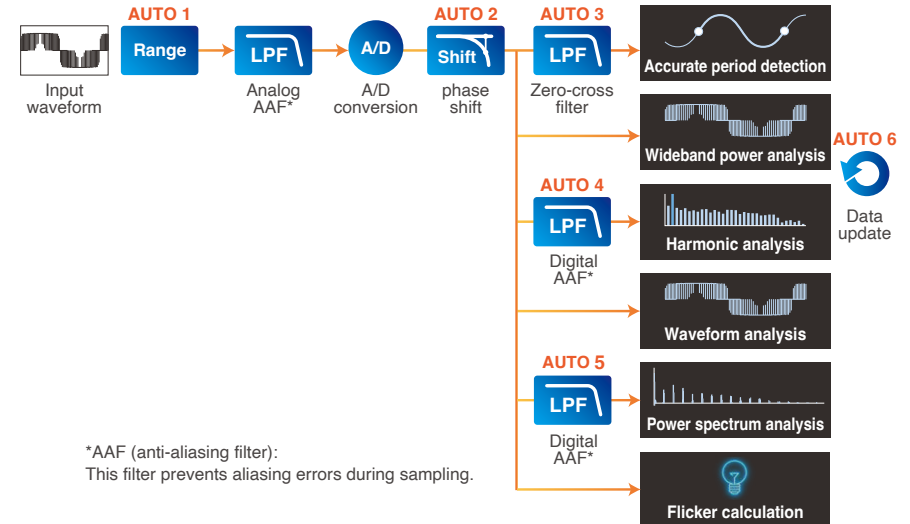
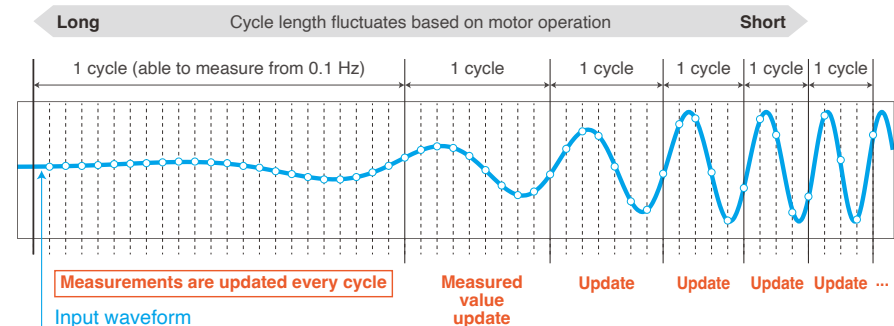

Illustration of auto data update operation



Flexible, expandable functionality

1 Acts like one 16-channel power analyzer

16-channel synchronized power measurement using an optical link interface*1

Change the secondary instrument's settings and collect secondary instrument data from the primary instrument. Obtain stable power efficiency measurement results with a simple system setup and no variations in data refresh timing between instruments.

2 Long-term observation of power fluctuations using D/A output*2

Waveform output (1 MS/s) and analog output (1 ms refresh)

PW8001 measurement data can be output to a general-purpose data logger, allowing fluctuations to be recorded over an extended period of time. Each channel can be set to either waveform output or analog output. The waveform output setting generates a voltage or current waveform at 1 MS/s, while the analog output setting generates the selected measured value at a refresh interval as short as 1 ms.

3 Parallel evaluation of multiple instruments

32-channel power measurement using synchronized BNC control **Ver. 2**

Four PW8001s can be connected and synchronized via BNC with one configured as the primary instrument and the other three as secondary instruments so that they can update and record data together. This approach makes it possible to evaluate entire systems at once, for example when you need to observe power consumption at various locations in an electric vehicle (EV).

4 Utilizing of data on a USB drive

FTP server function, FTP client function

Download or delete files on a USB drive connected to the PW8001. You can also automatically send measurement files to a PC's FTP server.

Ver. 2 This is a feature that will be supported in the upcoming firmware update.

*1: Models with optical link interface only.

*2: Models equipped with waveform & D/A output only.

1 User experience like that of a 16-channel power meter

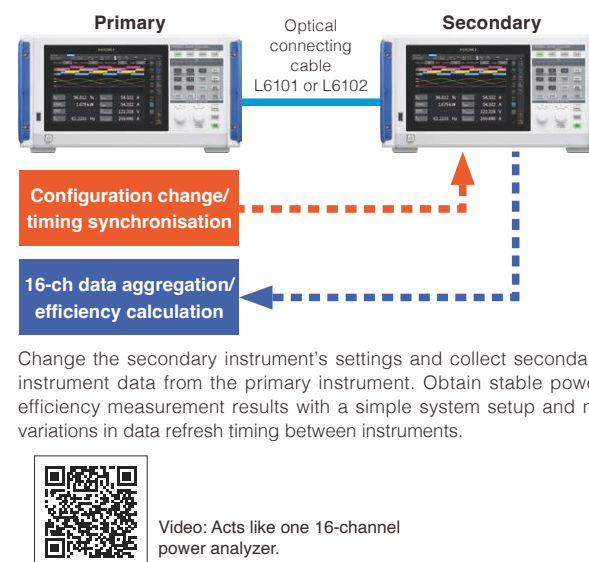

3 Parallel evaluation of multiple instruments



2 Long-term observation of power fluctuations using D/A output

20-channel output

Waveform output/analog output

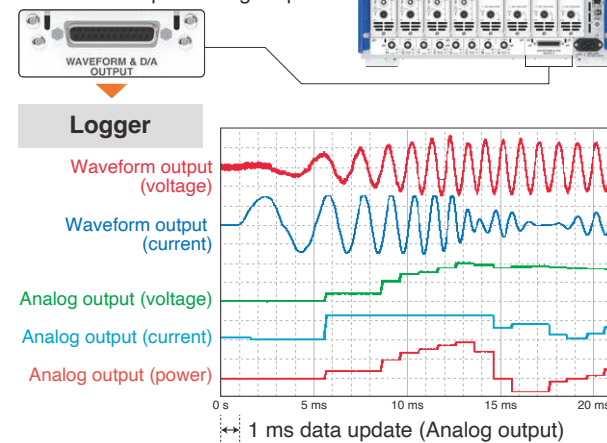

4 Utilizing of data on a USB drive

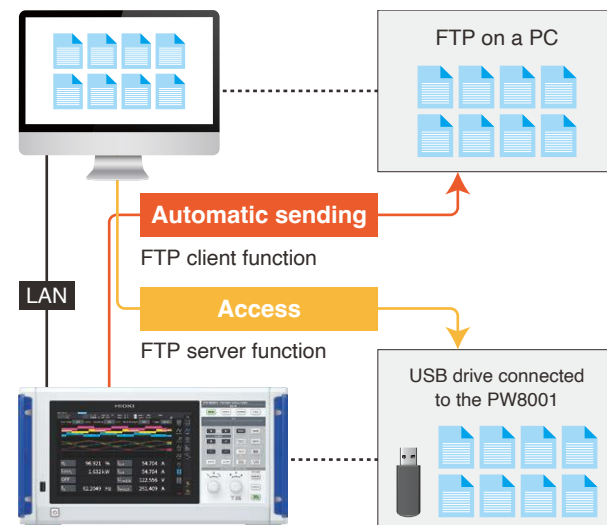

An interface that's designed to provide ease of use



Enjoy smooth operation thanks to a touch-panel display.



Adjust the displayed waveform position, triggers, and harmonic orders with intuitive knob-based operation.

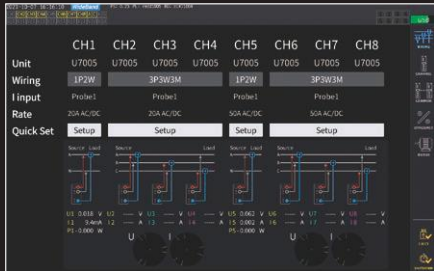

Use the connection confirmation screen to prevent wiring mistakes.



Optimize settings simply by selecting measurement type.

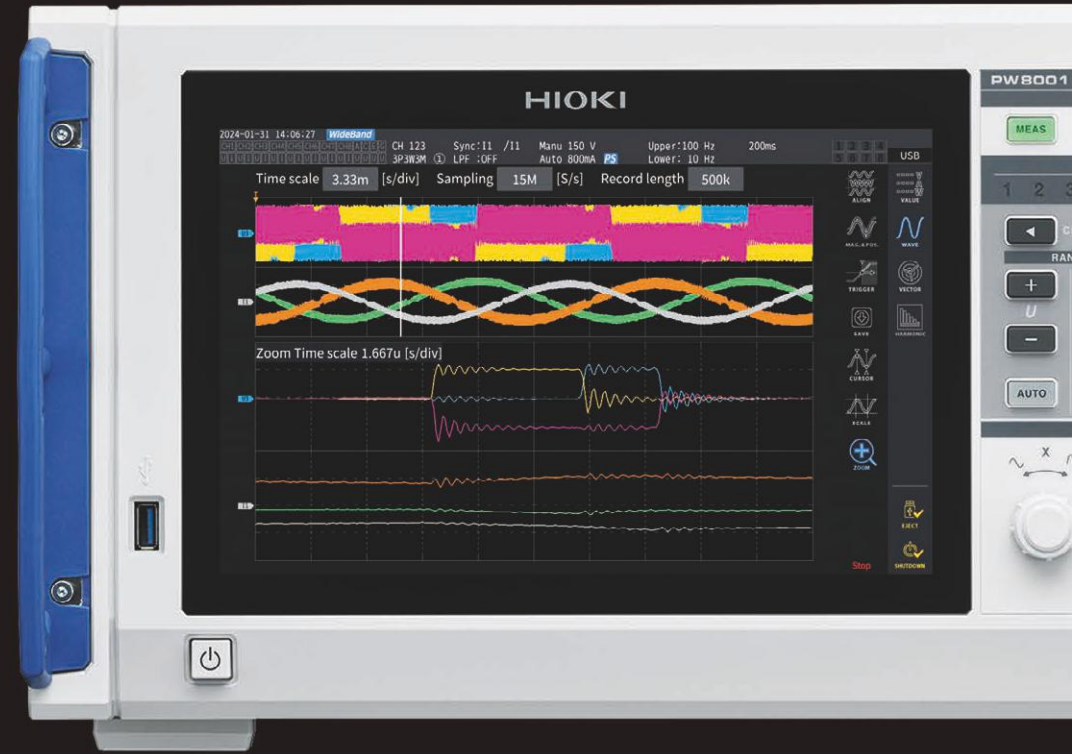

03.3573 Hz
328.080 V
133.358 A

Choose from two input units

Accommodate a broad range of applications, from R&D to shipping inspection.



2.5 MS/S INPUT UNIT U7001	
Basic accuracy for 50/60 Hz Power	$\pm 0.07\%$
Sampling frequency	2.5 MHz
ADC resolution	16-bit
Measurement frequency band	DC, 0.1 Hz to 1 MHz
Maximum input voltage	AC 1000 V, DC 1500 V, ± 2000 V peak
Maximum rated line-to-ground voltage	600 V AC, 1000 V DC CAT III 1000 V AC, 1500 V DC CAT II



15 MS/S INPUT UNIT U7005	
Basic accuracy for 50/60 Hz Power	$\pm 0.03\%$
Sampling frequency	15 MHz
ADC resolution	18-bit
Measurement frequency band	DC, 0.1 Hz to 5 MHz
Maximum input voltage	1000 V AC, 1000 V DC, ± 2000 V peak
Maximum rated line-to-ground voltage	600 V CAT III 1000 V CAT II

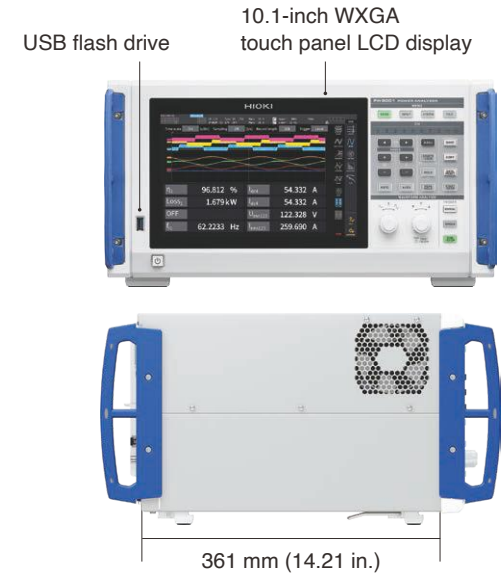

361 mm (14.21 in.)

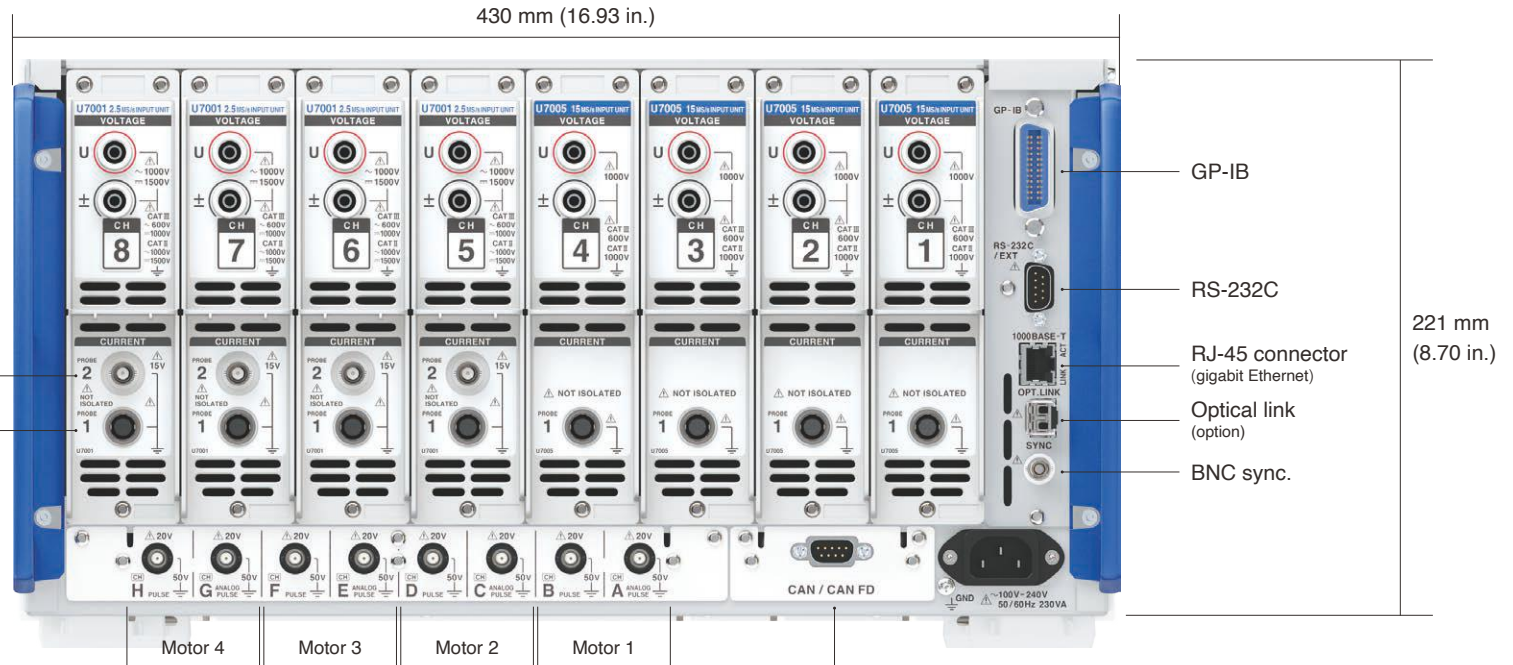

430 mm (16.93 in.)

221 mm (8.70 in.)

Probe 2
Current sensor terminals

Probe 1
High-performance current sensor terminals

Probe 1: High-performance current sensor terminals:
Connects an optional current sensors sold separately (see pages 26 to 29). The unit provides functionality for automatically detecting and powering the sensor.

Probe 2: Current sensor terminals:
Connect sensors with BNC output terminals, for example a current probe or CT.

Analyze four motors simultaneously (option)

CAN or CAN FD interface (option)
Waveform & D/A output (option)
Select either type of output (pictured: CAN or CAN FD).



Smoothly convert measurement data into evaluation data for efficient data management

1 Remote control from a PC web browser

HTTP server function

You can view the PW8001 display screen and operation panel from the web browser of up to five PCs. You can operate the PW8001 from one of them.

2 Record measurements accurately with high-speed data collection

PW8001 Data Receiver

Using a computer, data can be acquired from the PW8001 at up to 1 ms/S, the same data refresh rate as the PW8001. In addition, you can control the instrument remotely and acquire waveform data.

3 Evaluate on one screen by consolidating your data

GENNECT One SF4000

Combine the PW8001 with other instruments like the Memory HiLogger LR8450 to make simultaneous measurements. You can connect to up to 30 instruments to display and record measurement data from all of them simultaneously, allowing centralized data management.

4 Embedding in Modbus-based systems

Support for the Modbus TCP (Ethernet) communications protocol

The PW8001 can be embedded into control and SCADA systems based on Modbus.

5 Use in a measurement system

LabVIEW® driver and MATLAB® toolkits*

LabVIEW's simple GUI operation and the use of MATLAB functions allow you to quickly build measurement systems.



*LabVIEW is a registered trademark of National Instruments.
MATLAB is a registered trademark of Mathworks, Inc.

1 Remote control from a PC web browser

Control and view a PW8001 from multiple PCs

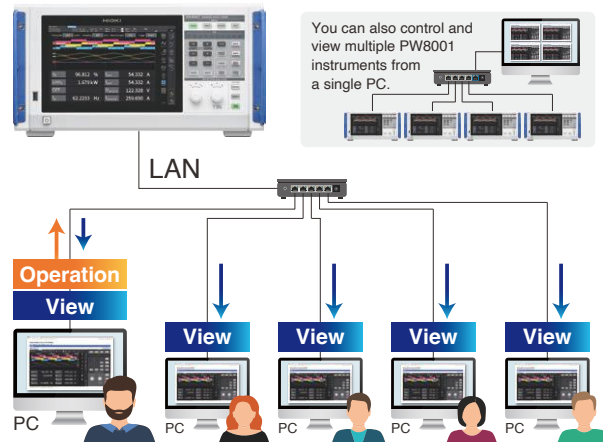

2 Record measurements accurately with high-speed data collection

PW8001 Data Receiver

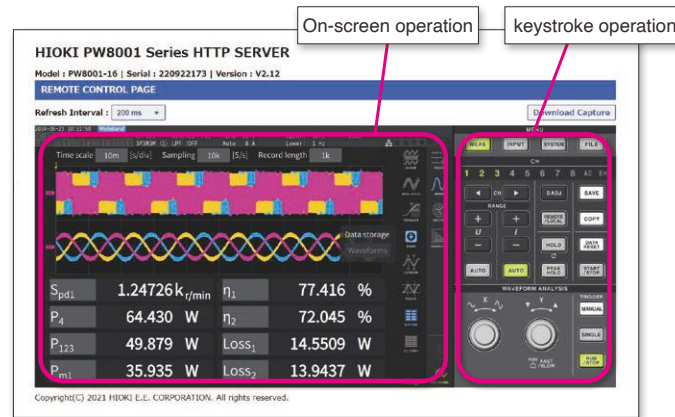

The ability to control the PW8001 remotely from a computer lets you change settings, switch measurement screens, and monitor data.

Data recording interval	Maximum number of items to be acquired
1 ms	50 items
10 ms	500 items
50 ms	2,500 items
100 ms	5,000 items
Over 200 ms	10,000 items

Acquire PW8001 measurement data at high-speed from a computer and save it as a CSV file.

3 Evaluate on one screen by consolidating your data

Group together and display data from multiple instruments

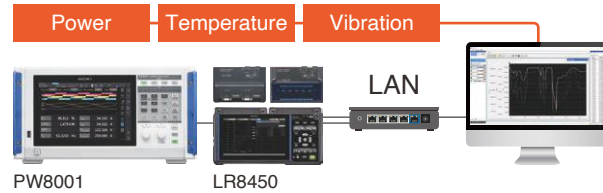

Connect up to 30 instruments to one PC.

Freely place measured values onto a custom image

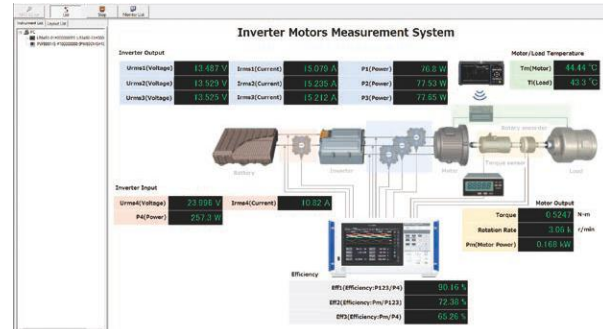

4 Embedding in Modbus-based systems

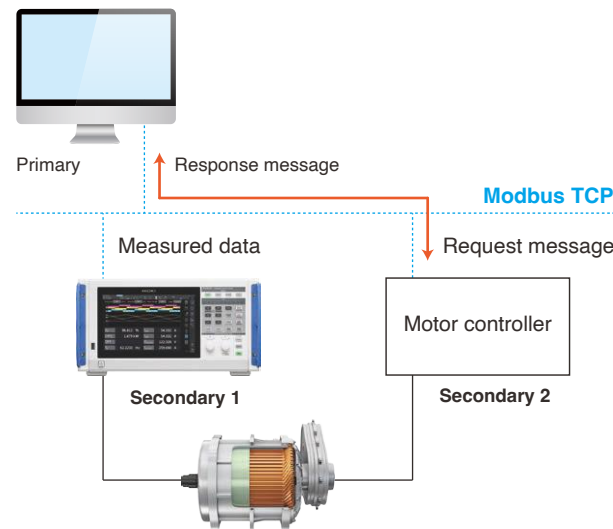

5 Use in a measurement system

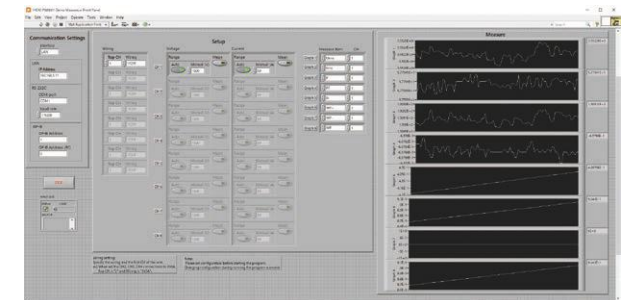

Hioki provides multiple LabVIEW® sample programs, including to configure settings and acquire data.

*LabVIEW® is a registered trademark of National Instruments.

Going Beyond Measure

Hioki is dedicated to contributing to the security and development of society by promoting customers' safe, efficient use of energy through electrical measurement.

As worldwide demand for energy continues to grow, this commitment embodies our mission and value as a company that supplies "mother tools" for industry. Hioki is working with customers to help create a sustainable society by evolving measurement as an industry frontrunner.

PW3390



PW8001



PW6001



Power analyzer lineup

Model	PW8001+U7005	PW8001+U7001	PW6001	PW3390
Applications	For measurement of SiC and GaN inverters and reactor/transformer loss	For measurement of high-efficiency IGBT inverters and solar inverters	For measurement of high-efficiency IGBT inverters	Balance of high accuracy and portability
Measurement frequency band	DC, 0.1 Hz to 5 MHz	DC, 0.1 Hz to 1 MHz	DC, 0.1 Hz to 2 MHz	DC, 0.5 Hz to 200 kHz
Basic accuracy for 50/60 Hz power	±(0.01% of reading + 0.02% of range)	±(0.02% of reading + 0.05% of range)	±(0.02% of reading + 0.03% of range)	±(0.04% of reading + 0.05% of range)
Accuracy for DC power	±(0.02% of reading + 0.03% of range)	±(0.02% of reading + 0.05% of range)	±(0.02% of reading + 0.05% of range)	±(0.05% of reading + 0.07% of range)
Accuracy for 10 kHz power	±(0.05% of reading + 0.05% of range)	±(0.2% of reading + 0.05% of range)	±(0.15% of reading + 0.1% of range)	±(0.2% of reading + 0.1% of range)
Accuracy for 50 kHz power	±(0.15% of reading + 0.05% of range)	±(0.4% of reading + 0.1% of range)	±(0.15% of reading + 0.1% of range)	±(0.4% of reading + 0.3% of range)
Number of power measurement channels	1 to 8 channels, specify U7001 or U7005 when placing an order (mixed available)		1 to 6 channels, a specify when ordering	4 channels
Voltage, current ADC sampling	18-bit, 15 MHz	16-bit, 2.5 MHz	18-bit, 5 MHz	16-bit, 500 kHz
Voltage range	6 V, 15 V, 30 V, 60 V, 150 V, 300 V, 600 V, 1500 V		6 V, 15 V, 30 V, 60 V, 150 V, 300 V, 600 V, 1500 V	15 V, 30 V, 60 V, 150 V, 300 V, 600 V, 1500 V
Current range	100 mA to 2000 A (6 ranges, based on sensor)	Probe 1: 100 mA to 2000 A (6 ranges, based on sensor) Probe 2: 100 mV, 200 mV, 500 mV, 1 V, 2 V, 5 V	Probe 1: 100 mA to 2000 A (6 ranges, based on sensor) Probe 2: 100 mV, 200 mV, 500 mV, 1 V, 2 V, 5 V	100 mA to 8000 A (6 ranges, based on sensor)
Common-mode voltage rejection ratio	50/60 Hz: 120 dB or greater 100 kHz: 110 dB or greater	50/60 Hz: 100 dB or greater 100 kHz: 80 dB typical	50/60 Hz: 100 dB or greater 100 kHz: 80 dB typical	50/60 Hz: 80 dB or greater
Temperature coefficient	0.01%/°C		0.01%/°C	0.01%/°C
Voltage input method	Photoisolated input, resistor voltage division	Isolated input, resistor voltage division	Photoisolated input, resistor voltage division	Isolated input, resistor voltage division
Current input method	Isolated input from current sensor		Isolated input from current sensor	Isolated input from current sensor
External current sensor input	Yes (ME15W)	Yes (ME15W, BNC)	Yes (ME15W, BNC)	Yes (ME15W)
Power supplied to external current sensor	Yes		Yes	Yes
Data update rate	1 ms, 10 ms, 50 ms, 200 ms		10 ms, 50 ms, 200 ms	50 ms
Maximum input voltage	1000 V, ±2000 V peak	1000 V AC, 1500 V DC, ±2000 V peak	1000 V, ±2000 V peak (10 ms)	1500 V, ±2000 V peak
Maximum rated line-to-ground voltage	600 V CATIII 1000 V CATII	600 V AC, 1000 V DC CATIII 1000 V AC, 1500 V DC CATII	600 V CATIII 1000 V CATII	600 V CATIII 1000 V CATII
Analysis	Maximum 4 motors*1		Maximum 2 motors*1	Maximum 1 motors*1
Motor analysis input format	Analog DC, frequency, pulse		Analog DC, frequency, pulse	Analog DC, frequency, pulse
Current sensor phase shift calculation	Yes (auto)		Yes	Yes
Harmonics measurement	Yes (8, for each channel)		Yes (6, for each channel)	Yes
Maximum harmonics analysis order	500th		100th	100th
Harmonics synchronization frequency range	0.1 Hz to 1.5 MHz	0.1 Hz to 1 MHz	0.1 Hz to 300 kHz	0.5 Hz to 5 kHz
IEC harmonics measurement	Yes		Yes	-
IEC flicker measurement	Yes		-	-
FFT spectrum analysis	Yes (DC to 6 MHz)	Yes (DC to 1 MHz)	Yes (DC to 2 MHz)	Yes (DC to 200 kHz)
FFT analysis items	U, I, P, torque (analog), RPM (analog)		U, I, torque (analog), RPM (analog)	U, I, torque (analog), RPM (analog)
User-defined calculations	Yes		Yes	-
Delta conversion	Yes (Δ-Y, Y-Δ)		Yes (Δ-Y, Y-Δ)	Yes (Δ-Y)
D/A output	Yes*1 20 ch (waveform output, analog output)		Yes*1 20 ch (waveform output, analog output)	Yes*1 16 ch (waveform output, analog output)
Display	10.1" WVGA TFT color LCD		9" WVGA TFT color LCD	9" WVGA TFT color LCD
Touch screen	Yes		Yes	-
External storage media	USB 3.0		USB 2.0	USB 2.0, CF card
LAN (100BASE-TX, 1000BASE-T)	Yes		Yes	Yes (10BASE-T and 100BASE-TX only)
GP-IB	Yes		Yes	-
RS-232C	Yes (maximum 115,200 bps)		Yes (maximum 230,400 bps)	Yes (maximum 38,400 bps)
External control	Yes		Yes	Yes
Synchronization of multiple instruments	Yes (up to 4 instruments)		-	Yes (up to 8 instruments)
Optical link	Yes*1		Yes	-
CAN or CAN FD	Yes*1		-	-
Dimensions, weight (W×H×D)	430 mm (16.93 in.) × 221 mm (8.70 in.) × 361 mm (14.21 in.), 14 kg (493.84 oz.)		430 mm (16.93 in.) × 177 mm (6.97 in.) × 450 mm (17.72 in.) 14 kg (493.84 oz.)	340 mm (13.39 in.) × 170 mm (6.69 in.) × 156 mm (6.14 in.) 4.6 kg (162.26 oz.)

*1: Sold separately

Basic Specifications

Input specifications

(1) Voltage, current, and power measurement shared specifications	
No. of PW8001 input units	Max. 8 units (mix and match)
Type of input unit	U7001 2.5 MS/s INPUT UNIT U7005 15 MS/s INPUT UNIT
Notes on mounting input units	When units are mixed, they are mounted and fixed so that U7005 occupies CH1 and that units of like kind are occupy adjacent channels.
Measurement lines	1-phase-2-wire (1P2W) 1-phase-3-wire (1P3W) 3-phase-3-wire (3P3W2M, 3V3A, 3P3W3M) 3-phase-4-wire (3P4W)
Connection settings	Mounted units can be assigned to connection channels. (However, only adjacent units can be used for the same connection.)
Measurement method	Voltage/current simultaneous digital sampling with zero-cross synchronized calculation
Sampling	U7001 2.5 MHz, 16-bit U7005 15 MHz, 18-bit
Measurement frequency band	U7001 DC, 0.1 Hz to 1 MHz U7005 DC, 0.1 Hz to 5 MHz
Frequency flatness	U7001 Band where amplitude falls within $\pm 0.1\%$ range: 100 kHz (typical) Band where phase falls within $\pm 0.1^\circ$ range: 300 kHz (typical) U7005 Band where amplitude falls within $\pm 0.1\%$ range: 300 kHz (typical) Band where phase falls within $\pm 0.1^\circ$ range: 500 kHz (typical)
Effective measurement range	1% of range to 110% of range Wideband measurement mode
Measurement modes	IEC measurement mode (scheduled to be supported in firmware Ver. 2.00)
Data update rate	1 ms, 10 ms, 50 ms, 200 ms When 1 ms is set, average and user-defined operations are not available. IEC measurement mode: Approx. 200 ms (50 Hz: 10 cycles; 60 Hz: 12 cycles)
LPF	U7001 Cutoff frequency: 500 Hz, 1 kHz, 5 kHz, 10 kHz, 50 kHz, 100 kHz, 500 kHz, OFF
	U7005 Cutoff frequency: 500 Hz, 1 kHz, 5 kHz, 10 kHz, 50 kHz, 100 kHz, 500 kHz, 2 MHz, OFF
Synchronization source	When not off, add $\pm 0.05\%$ of reading to accuracy. When the cutoff frequency is 500 Hz or 1 kHz, add $\pm 0.5\%$ of reading. Accuracy specifications are defined for frequencies that are 1/10 or less of the set cutoff frequency. Peak values are determined using values after signals have passed through the LPF, while peak-exceeded judgments are made using values before signals have passed through the digital LPF.
	U1 to U8, I1 to I8, DC (fixed at data update rate) PW8001-1x motor analysis option only Ext1 to Ext4, Zph1, Zph3, CH B, D, F, H Can be selected for each wiring method. (U/I on the same channel is measured using the same synchronization source.) When U or I is selected, the waveform zero-cross point after signals pass through the zero-cross filter is used as the reference. Only U or I can be selected when IEC measurement mode is selected.
Synchronization source effective frequency range	DC, 0.1 Hz to 2 MHz (U7001: up to 1 MHz)
Synchronization source effective input range	1% of range to 110% of range
Zero-cross filter	Used to detect voltage and current waveform zero-cross events. It does not affect measurement waveforms. It consists of LPF and HPF digital filters. Cutoff frequencies are determined automatically based on the upper and lower limit frequency settings and the measurement frequency. HPF can be turned on or off (fixed to "off" when IEC measurement mode is selected).

Measurement lower limit frequency	Select the from following frequencies for each connection: 0.1 Hz, 1 Hz, 10 Hz, 100 Hz, 1 kHz, 10 kHz, 100 kHz When IEC measurement mode is selected, the frequency is fixed (cannot be selected by the user).
Measurement upper limit frequency	Select from the following frequencies for each connection: 100 Hz, 500 Hz, 1 kHz, 5 kHz, 10 kHz, 50 kHz, 100 kHz, 500 kHz, 1 MHz, 2 MHz
Polarity detection	Voltage/current zero-cross timing comparison method
Measurement parameters	voltage (U), current (I), active power (P), apparent power (S), reactive power (Q), power factor (λ), phase angle (ϕ), voltage frequency (fU), current frequency (fI), efficiency (η), loss, voltage ripple factor (Urf), current ripple factor (Irf), current integration (Ih), power integration (WP), voltage peak (Upk), current peak (Ipk)
(2) Voltage measurement specifications	
Input terminal profile	Plug-in terminals (safety terminals)
Input method	Isolated input, resistor voltage division
Display range	RMS, DC: 0% to 150% of range (1500 V range: 0% to 135%) Waveform peak: 0% to 300% of range (1500 V range: 0% to 135%)
Range	6 V, 15 V, 30 V, 60 V, 150 V, 300 V, 600 V, 1500 V
Crest factor	3 (relative to voltage/current range rating) however, 1.35 for 1500 V range
Input resistance	U7001 2 M Ω ± 20 k Ω , 1 pF typical
Input capacitance	U7005 4 M Ω ± 20 k Ω , 6 pF typical
Maximum input voltage	U7001 1000 V AC, 1500 V DC or ± 2000 V peak 1000 V, ± 2000 V peak U7005 Input voltage frequency: 400 kHz $< f \leq 1000$ kHz, (1300 - f) V Input voltage frequency: 1000 kHz $< f \leq 5000$ kHz, 200 V Unit for f above: kHz
Maximum rated line-to-ground voltage	U7001 600 V AC, 1000 V DC CAT III, anticipated transient overvoltage 8000 V 1000 V AC, 1500 V DC CAT II, anticipated transient overvoltage 8000 V U7005 600 V CAT III anticipated transient overvoltage 6000 V 1000 V CAT II anticipated transient overvoltage 6000 V
(3) Current measurement specifications (probe 2: U7001 only)	
Input terminal profile	Probe1 Dedicated connector (ME15W)
	Probe2 BNC (metal) (female connector)
Input method	Probe 1 (current sensor input) or probe 2 (external input) is selected depending on the settings. The same input settings apply to the same connection channel.
Input method	Current sensor method
Display range	RMS, DC: 0% to 150% of range Waveform peak: 0% to 300% of range
Range	with 2 A sensor : 40 mA, 80 mA, 200 mA, 400 mA, 800 mA, 2 A
	with 20 A sensor : 400 mA, 800 mA, 2 A, 4 A, 8 A, 20 A
	with 200 A sensor : 4 A, 8 A, 20 A, 40 A, 80 A, 200 A
	with 2000 A sensor : 40 A, 80 A, 200 A, 400 A, 800 A, 2 kA
	with 5 A sensor : 100 mA, 200 mA, 500 mA, 1 A, 2 A, 5 A
	with 50 A sensor : 1 A, 2 A, 5 A, 10 A, 20 A, 50 A
	with 500 A sensor : 10 A, 20 A, 50 A, 100 A, 200 A, 500 A
	with 1000 A sensor : 20 A, 40 A, 100 A, 200 A, 400 A, 1 kA
	One ampere range can be set for one wiring method. The same sensor must be used for the same wiring method.
	0.1 mV/A : 1 kA, 2 kA, 5 kA, 10 kA, 20 kA, 50 kA 1 mV/A : 100 A, 200 A, 500 A, 1 kA, 2 kA, 5 kA 10 mV/A : 10 A, 20 A, 50 A, 100 A, 200 A, 500 A 100 mV/A : 1 A, 2 A, 5 A, 10 A, 20 A, 50 A 1 V/A : 100 mA, 200 mA, 500 mA, 1 A, 2 A, 5 A
(0.1 V, 0.2 V, 0.5 V, 1.0 V, 2.0 V, 5.0 V ranges) Input rate and range for each wiring method.	
Crest factor	For current range rating: 3 (However, for probe 2's 5 V range: 1.5)
Input resistance	Probe1 1 M Ω ± 50 k Ω
Input capacitance	Probe2 1 M Ω ± 50 k Ω / 22 pF typical
Maximum input voltage	Probe1 8 V, ± 12 V peak (10 ms or less) Probe2 ± 15 V, ± 20 V peak (10 ms or less)

(4) Frequency measurement

Number of measurement channels	Max. 8 channels (fU1 to fU8, fI1 to fI8), Varies with number of installed units.
Measurement method	Reciprocal method, waveforms are measured after application of the zero-cross filter.
Measurement range	0.1 Hz to 2 MHz (Display shows 0.00000 Hz or ----- Hz if measurement is not possible.) Limits are determined by the input unit's measurement band and the lowest frequency set by the user.
Measurement accuracy	± 0.005 Hz (Voltage frequency measurement with a measurement interval of 50 ms or greater, voltage 15 V range or greater, and 50% or greater sine wave input at 45 to 66 Hz) At conditions other than above, $\pm 0.05\%$ of reading (For sine waves of 30% or greater of the measurement source's measurement range)
Display resolution	0.10000 Hz to 9.99999 Hz, 9.9000 Hz to 99.9999 Hz, 99.000 Hz to 999.999 Hz, 0.99000 kHz to 9.99999 kHz, 9.9000 kHz to 99.9999 kHz, 99.000 kHz to 999.999 kHz, 0.99000 MHz to 2.00000 MHz

(5) Integration measurement

Measurement modes	Select RMS or DC for each wiring method (DC mode can only be selected when using an AC/DC sensor with a 1P2W wiring).
Measurement parameters	Current integration (Ih+, Ih-, Ih), active power integration (WP+, WP-, WP) Ih+ and Ih- are measured only in DC mode. Only Ih is measured in RMS mode.
Measurement method	Digital calculations based on current and active power values (Averaging: calculated values that are attained immediately before averaging) DC mode: current and instantaneous power values for each sampling interval are integrated for each polarity. RMS mode: current RMS and active power values for measurement intervals are integrated; only active power is calculated for each polarity. (Active power is integrated by polarity for each synchronization source period.) (Multi-phase wiring active power integration SUM values are calculated by integrating the sum of active power values for each measurement interval by polarity.)
Measurement interval	Same as data refresh rate
Display resolution	999999 (6 digits + decimal point), starting from the resolution at which 1% of each range is 100% of range
Measurement range	0 to ± 99.9999 PAH/PWH
Integration time	0 sec. to 9999 hr. 56 min. 59 sec. (Integration will stop if the integration time exceeds this range.)
Integration time accuracy	$\pm 0.02\%$ of reading (-10°C to 40°C, -14°F to 104°F)
Integration accuracy	\pm (current or active power accuracy) \pm integration time accuracy
Backup function	None
Integration control	All-channel synchronized integration: Manual control, actual time control, timer control Connection-specific independent integration: Manual control, actual time control, timer control • Data is not saved. • The optical link cannot be used when IEC measurement mode is selected or during BNC synchronization.

(6) Harmonics measurement

Number of measurement channels	Max. 8 channels Varies with number of installed units.
Synchronization source	Based on the synchronization source setting for each connection
Measurement modes	Select from wideband mode or IEC standard mode* (setting applies to all channels). *To be supported in ver. 2.00

Measurement parameters	Harmonic voltage RMS value, harmonic voltage content ratio, harmonic voltage phase angle, harmonic current RMS value, harmonic current content ratio, harmonic current phase angle, harmonic active power, harmonic power content ratio, harmonic voltage/current phase difference, total voltage harmonic distortion, total current harmonic distortion, voltage unbalance ratio, current unbalance ratio, intermediate harmonic voltage RMS value (IEC measurement mode), intermediate harmonic current RMS value (IEC measurement mode)
FFT processing word length	32-bit
Antialiasing	Digital filter (automatically configured based on synchronization frequency)
Window function	Rectangular
Grouping	OFF, Type 1 (harmonic sub-group), Type 2 (harmonic group), (setting applies to all channels)
THD calculation method	THD_F or THD_R, select calculation order from 2nd order to 100th order (however, limited to the maximum analysis order for each mode) (setting applies to all channels)

(7) IEC measurement mode: IEC standard harmonic measurement	
Measurement method	IEC61000-4-7:2002+A1:2008 compliant
Measurement frequency setting	50 Hz / 60 Hz (Synchronization source does not operate for DC.)
Synchronization frequency range	When set to 50 Hz: 45 Hz to 55 Hz When set to 60 Hz: 45 Hz to 66 Hz
Data update rate	Approx. 200 ms (50 Hz: 10 waves; 60 Hz: 12 waves)
Analysis orders	Harmonics: 0th to 200th order Intermediate harmonics: 0.5th to 200.5th order
Window wave number	When less than 56 Hz, 10 waves; when 56 Hz or greater, 12 waves
FFT Number of points	8192 points
Measurement accuracy	Add $\pm 0.04\%$ of the range to each of the basic accuracies for the module in use (voltage, current, power, and phase). For a frequency of 10 kHz or more, add another $\pm 0.04\%$ of the range.

(8) Wideband measurement mode: wideband harmonic measurement			
Measurement method	Zero-cross synchronization calculation method (same window for each synchronization source) with gaps. Fixed sampling interpolation calculation method		
Synchronization frequency range	0.1 Hz to 1.5 MHz (U7001: up to 1 MHz)		
Data update rate	Fixed at 50 ms When set to 10 ms or less: only harmonics measurement operate at 50 ms. When set to 200 ms: uses values obtained by averaging four sets of 50 ms data.		
Maximum analysis order and Window wave number	Fundamental frequency	Window wave number	Maximum analysis order
	0.1 Hz $\leq f \leq 2$ kHz	1	500th
	2 kHz $< f \leq 5$ kHz	1	300th
	5 kHz $< f \leq 10$ kHz	2	150th
	10 kHz $< f \leq 20$ kHz	4	75th
	20 kHz $< f \leq 50$ kHz	8	30th
	50 kHz $< f \leq 100$ kHz	16	15th
Phase zero-adjustment	100 kHz $< f \leq 200$ kHz	32	7th
	200 kHz $< f \leq 300$ kHz	64	5th
	300 kHz $< f \leq 500$ kHz	128	3rd
	500 kHz $< f \leq 1.5$ MHz	256	1st
	U7001: Up to 1 MHz		
Phase zero-adjustment	The instrument provides phase zero-adjustment functionality using keys or communications commands (only available when the synchronization source is set to Ext). Phase angle zero-adjustment values can be set automatically or manually. Phase angle zero-adjustment setting range 0.000° to $\pm 180.000^\circ$ (in 0.001° increments)		
No. of FFT points	Automatically selected from 2048, 4096, or 8192 points.		

Measurement accuracy	Add following to each unit's voltage, current, and power accuracy. However, add 0.05% of reading for fundamental wave 2 kHz or greater.		
	Frequency	voltage, current, power \pm (% of reading)	Phase difference \pm (°)
	DC	0.05%	-
	0.1 Hz $\leq f \leq 100$ Hz	0.01%	0.1°
	100 Hz $< f \leq 1$ kHz	0.03%	0.1°
	1 kHz $< f \leq 10$ kHz	0.08%	0.6°
	10 kHz $< f \leq 50$ kHz	0.15%	$(0.020 \times f) \pm 0.5^\circ$
50 kHz $< f \leq 1$ MHz	0.20%	$(0.030 \times f) \pm 2.0^\circ$	
1 MHz $< f \leq 1.5$ MHz	0.25%	$(0.040 \times f) \pm 2.5^\circ$	
Unit for f in accuracy calculations as mentioned in the table above: kHz The figures for voltage, current, power, and phase difference for frequencies in excess of 300 kHz are reference values. When the fundamental wave is outside the range of 16 Hz to 850 Hz, the figures for voltage, current, power, and phase difference for frequencies other than the fundamental wave are reference values. When the fundamental wave is within the range of 16 Hz to 850 Hz, the figures for voltage, current, power, and phase difference in excess of 6 kHz are reference values. Accuracy values for phase difference are defined for input for which the voltage and current for the same order are at least 10% f.s.			

Measurement accuracy

Accuracy guarantee conditions	Accuracy guarantee period: 6 months (Multiply the 6-month accuracy reading error to obtain the 1-year accuracy.) Accuracy guarantee temperature and humidity range: 23°C $\pm 3^\circ\text{C}$, 80% RH or less Warm-up time: 30 min. or greater Sine wave input at a power factor of 1 or DC input with a line voltage of 0 V within $\pm 1^\circ\text{C}$ after zero-adjustment and within active measurement range.
-------------------------------	--

Voltage (U)

Accuracy	U7001	U7005
	\pm (% of reading + % of range)	
DC	0.02% + 0.05%	0.02% + 0.03%
0.1 Hz $\leq f < 45$ Hz	0.1% + 0.1%	
45 Hz $\leq f \leq 440$ Hz	0.02% + 0.05%	0.01% + 0.02%
440 Hz $< f \leq 1$ kHz	0.03% + 0.05%	0.02% + 0.04%
1 kHz $< f \leq 10$ kHz	0.15% + 0.05%	0.05% + 0.05%
10 kHz $< f \leq 50$ kHz	0.20% + 0.05%	0.1% + 0.05%
50 kHz $< f \leq 100$ kHz	$(0.01 \times f)\% + 0.1\%$	
100 kHz $< f \leq 500$ kHz	$(0.02 \times f)\% + 0.2\%$	$(0.01 \times f)\% + 0.2\%$
500 kHz $< f \leq 1$ MHz	-	$(0.01 \times f)\% + 0.3\%$
Frequency band	1 MHz (-3 dB typical)	5 MHz (-3 dB typical)

Current (I)

Accuracy	U7001	U7005
	\pm (% of reading + % of range)	
DC	0.02% + 0.05%	0.02% + 0.03%
0.1 Hz $\leq f < 45$ Hz	0.1% + 0.1%	
45 Hz $\leq f \leq 440$ Hz	0.02% + 0.05%	0.01% + 0.02%
440 Hz $< f \leq 1$ kHz	0.03% + 0.05%	0.02% + 0.04%
1 kHz $< f \leq 10$ kHz	0.15% + 0.05%	0.05% + 0.05%
10 kHz $< f \leq 50$ kHz	0.20% + 0.05%	0.1% + 0.05%
50 kHz $< f \leq 100$ kHz	$(0.01 \times f)\% + 0.1\%$	
100 kHz $< f \leq 500$ kHz	$(0.02 \times f)\% + 0.2\%$	$(0.01 \times f)\% + 0.2\%$
500 kHz $< f \leq 1$ MHz	-	$(0.01 \times f)\% + 0.3\%$
Frequency band	1 MHz (-3 dB typical)	5 MHz (-3dB typical)

Active power (P)		
Accuracy	U7001	U7005
	\pm (% of reading + % of range)	
DC	0.02% + 0.05%	0.02% + 0.03%
0.1 Hz $\leq f < 30$ Hz	0.1% + 0.2%	
30 Hz $\leq f < 45$ Hz	0.1% + 0.1%	
45 Hz $\leq f \leq 440$ Hz	0.02% + 0.05%	0.01% + 0.02%
440 Hz $< f \leq 1$ kHz	0.05% + 0.05%	0.02% + 0.04%
1 kHz $< f \leq 10$ kHz	0.20% + 0.05%	0.05% + 0.05%
10 kHz $< f \leq 50$ kHz	0.40% + 0.1%	0.15% + 0.05%
50 kHz $< f \leq 100$ kHz	$(0.01 \times f)\% + 0.2\%$	
100 kHz $< f \leq 500$ kHz	$(0.025 \times f)\% + 0.3\%$	$(0.01 \times f)\% + 0.3\%$
500 kHz $< f \leq 1$ MHz	-	$(0.01 \times f)\% + 0.5\%$

power phase angle (ϕ)		
Accuracy	U7001	U7005
	\pm (% of reading + % of range)	
0.1 Hz $\leq f \leq 1$ kHz	$\pm 0.05^\circ$	
1 kHz $< f \leq 10$ kHz	$\pm 0.2^\circ$	$\pm 0.12^\circ$
10 kHz $< f \leq 50$ kHz	$\pm(0.02 \times f)^\circ$	$\pm 0.2^\circ$
50 kHz $< f \leq 100$ kHz	$\pm(0.02 \times f)^\circ$	$\pm 0.4^\circ$
100 kHz $< f \leq 500$ kHz	$\pm(0.02 \times f)^\circ$	$\pm(0.01 \times f)^\circ$
500 kHz $< f \leq 1$ MHz	-	$\pm(0.01 \times f)^\circ$

- Unit for "f" in accuracy calculations as mentioned in the table above: kHz
- Voltage and current DC values are defined for Udc and Idc, while frequencies other than DC are defined for Urms and Irms.
- When U or I is selected as the synchronization source, accuracy is defined for source input of at least 5% f.s.
- Power phase angle accuracy is defined at a power factor of zero with 100% input.
- Add the current sensor accuracy to the above accuracy figures for current, active power, and phase difference.
- The accuracy figures for voltage, current, active power, and phase difference for 0.1 Hz $\leq f < 10$ Hz are reference values.
- The accuracy figures for voltage, active power, and phase difference in excess of 220 V from 10 Hz $\leq f < 16$ Hz are reference values.
- The accuracy figures for voltage, active power, and phase difference in excess of 750 V from 30 kHz $< f \leq 100$ kHz are reference values.
- The accuracy figures for voltage, active power, and phase difference in excess of $(22000/f [\text{kHz}])$ V from 100 kHz $< f \leq 1$ MHz are reference values.
- For the voltage 6 V range, add $\pm 0.02\%$ of range to voltage and active power accuracy.
- When using probe 1 and the sensor's rated 1/50 range, add $\pm 0.02\%$ of range to current and active power accuracy (U7001).
- When using probe 1 and the sensor's rated 1/10, 1/25, and 1/50 range, add $\pm 0.02\%$ of range to current and active power accuracy (U7005).
- When using probe 2, add $\pm(0.05\%$ of reading + 0.2% of range) to current and active power accuracy. At 10 kHz or greater, add $\pm 0.2^\circ$ to power phase angle accuracy (U7001).
- When 100% of range $<$ input $\leq 110\%$ of range, range error $\times 1.1$.
- With a temperature change of $\pm 1^\circ\text{C}$ or greater after zero-adjustment, add $\pm 0.01\%$ of range-per- $^\circ\text{C}$ to the voltage DC accuracy.
- When using probe 1, add $\pm 0.01\%$ of range per $^\circ\text{C}$ to the current and active power DC accuracy.
- When using probe 2, add $\pm 0.05\%$ of range per $^\circ\text{C}$ to the current and active power DC accuracy.
- For voltages in excess of 600 V, add the following to the power phase angle accuracy:
 - 0.1 Hz $< f \leq 500$ Hz $\pm 0.1^\circ$, 500 Hz $< f \leq 5$ kHz $\pm 0.3^\circ$,
 - 5 kHz $< f \leq 20$ kHz $\pm 0.5^\circ$, 20 kHz $< f \leq 200$ kHz $\pm 1^\circ$
- The effective measurement range of 9272-05 is 0.5 % of full scale to 100% of full scale.
- When measuring 900 V or greater, add the following to the voltage and active power accuracy: $\pm 0.02\%$ of reading (U7001). The effects of self-heating will persist until the input resistance temperature decreases even if the voltage input value is low.
- When measuring 800 V or greater, add the following to the voltage and active power accuracy: $\pm 0.01\%$ of reading (U7005). The effects of self-heating will persist until the input resistance temperature decreases even if the voltage input value is low.
- When 1000 V $<$ DC voltage ≤ 1500 V, add 0.045% of reading to the voltage and active power accuracy. The measurement accuracy figures are determined by the design (U7001).
- **The DC voltage and DC active power accuracy, when 1000 V $<$ DC voltage ≤ 1500 V, can be guaranteed by having special-order calibration performed (U7001).**

Apparent power (S) Measurement accuracy	Voltage accuracy + current accuracy ± 10 digits
Reactive power (Q) Measurement accuracy	Other than $\phi = 0^\circ$ or $\pm 180^\circ$: Apparent power accuracy $\pm (1 - \sin[\phi + \text{power phase angle accuracy}] / \sin\phi) \times 100\%$ of reading $\pm (\sqrt{(1.001 - \lambda^2)} - \sqrt{(1 - \lambda^2)}) \times 100\%$ of range When $\phi = 0^\circ$ or $\pm 180^\circ$: Apparent power accuracy $\pm (\sin[\text{power phase angle accuracy}]) \times 100\%$ of range $\pm 3.16\%$ of range λ : power factor display value
Power factor (λ) Measurement accuracy	Other than $\phi = 90^\circ$: $\pm (1 - \cos[\phi + \text{power phase angle accuracy}] / \cos\phi) \times 100\%$ of reading ± 50 digits When $\phi = 90^\circ$: $\pm \cos[\phi + \text{power phase angle accuracy}] \times 100\%$ of range ± 50 digits ϕ : power phase angle display value In both cases, accuracy is defined for voltage/current range rated input.
Waveform peak measurement accuracy	Voltage or current RMS value accuracy $\pm 1\%$ of range (applying 300% of the range as peak range)
Effects of temperature	Probe1 Add the following to the voltage, current, and active power accuracy within the range of 0°C to 20°C and 26°C to 40°C $\pm 0.01\%$ of reading / $^\circ\text{C}$, for DC, add an additional 0.01% of range per $^\circ\text{C}$
	Probe2 Voltage: $\pm 0.01\%$ of reading / $^\circ\text{C}$, for DC, add an additional 0.01% of range per $^\circ\text{C}$ Current, active power: $\pm 0.03\%$ of reading / $^\circ\text{C}$, for DC, add an additional 0.06% of range per $^\circ\text{C}$
Common-mode rejection ratio (effects of commonmode voltage)	U7001 50/60 Hz: 100 dB or greater 100 kHz: 80 dB typical
	U7005 50/60 Hz: 120 dB or greater 100 kHz: 110 dB typical of greater
Effects of external magnetic fields	Defined for CMRR for all measurement ranges when the maximum input voltage is applied between the voltage input terminal and the enclosure. $\pm 1\%$ of range or less (in a magnetic field of 400 A/m, DC or 50/60 Hz)
Effects of power factor on active power	ϕ of other than $\pm 90^\circ$: $\pm (1 - \cos[\phi + \text{phase difference accuracy}] / \cos\phi) \times 100\%$ of reading ϕ of $\pm 90^\circ$: $\pm \cos[\phi + \text{phase difference accuracy}] \times 100\%$ of VA
Effect of conducted radio frequency electromagnetic field	When 3 V, $\pm 6\%$ of full scale or less for current and active power (f.s. is the rated primary current value of the current sensor; only when 9272-05 is used)
Effect of radiated radio frequency electromagnetic field	When 10 V/m, $\pm 6\%$ of full scale or less for current and active power (f.s. is the rated primary current value of the current sensor; only when 9272-05 is used)

Waveform recording

Number of measurement channels	Voltage and current waveforms: Max. 8 channels (varies with number of installed units) Motor waveforms*: Max. 4 analog DC channels + max. 8 pulse channels
Recording capacity	5 M word \times ([voltage/current] \times max. 8 channels + motor waveforms*), no memory allocation function
Waveform resolution	16-bit (U7005 voltage and current waveforms use upper 16 bits.)
Sampling speed	Voltage and current waveforms: always 15 MS/s (The U7001 interpolates 2.5 MS data using 0th order hold.) Motor waveforms (analog DC)*: always 1 MS/s (Interpolates 1 MS data using 0th order hold.) Motor waveforms (analog pulse)*: always 15 MS/s
Compression ratio	1/1, 1/2, 1/3, 1/6, 1/15, 1/30, 1/60, 1/150, 1/300, 1/600, 1/1500 (15 MS/s, 7.5 MS/s, 5 MS/s, 2.5 MS/s, 1.0 MS/s, 500 kS/s, 250 kS/s, 100 kS/s, 50 kS/s, 25 kS/s, 10 kS/s) However, motor waveforms (analog DC) are only compressed at 1 MS/s or less.
Recording length	1 k-word, 5 k-word, 10 k-word, 50 k-word, 100 k-word, 500 k-word, 1 M-word
Storage mode	Peak-to-peak compression
Trigger mode	SINGLE or NORMAL (with auto-trigger setting)
Pre-trigger	0% to 100% of the recording length, in 10% steps
Trigger detection method	Level trigger (Detects the trigger based on fluctuations in the level of the storage waveform.) Trigger sources: voltage and current waveform, waveform after voltage and current zero-cross filter, manual, motor waveform, motor pulse Trigger slopes: rising edge, falling edge Trigger level: $\pm 300\%$ of the range for the waveform, in 0.1% steps Event triggers Detect triggers based on fluctuations in the value of a basic measurement parameter (except flicker measurement parameters). Trigger detection conditions are set using OR and AND operators for the four events defined below. AND takes precedence over OR. Events: Consist of a basic measurement parameter (except flicker measurement parameters), an inequality sign (<, >), and a value (0 to $\pm 99999.9\text{T}$). Ev n: Item _ X.XXXXX y n: 1 to 4 Item: Basic measurement parameter _: Inequality sign X.XXXXX: 6-digit constant y: SI prefix

*PW8001-11, -12, -13, -14, -15, and -16 models with motor analysis option only.

FFT analysis (to be supported in ver. 2.00)

Measurement channel	Voltage-current waveform: selected by connection. Max. 3 channels Motor waveforms: Analog DC Analysis performed only when FFT screen is displayed
Calculation type	RMS spectrum: (When multiple channels are selected, average for each channel) Power spectrum: (Active power [P]; however, only when voltage or current waveform is selected. When multiple channels are selected, values are added for each channel [Psum].)
Number of FFT points	1,000, 5,000, 10,000 or 50,000 points
FFT processing word length	32 bits
Analysis position	User-selected position in waveform recording data
Anti-aliasing	Automatic digital filter
Window function	Rectangular, hanning, flat-top
Max. analysis frequency (Linked to waveform recording compression ratio)	Voltage and current waveforms: 6 MHz, 3 MHz, 2 MHz, 1 MHz, 400 kHz, 200 kHz, 100 kHz, 40 kHz, 20 kHz, 10 kHz, 4 kHz (When the U7001 or multiple channels including the U7001 are selected, 1 MHz is the upper limit.) Motor waveform input: 400 kHz, 200 kHz, 100 kHz, 40 kHz, 20 kHz, 10 kHz, 4 kHz The maximum analysis frequency is calculated as follows: (above frequency - frequency resolution)
FFT peak value display	Ten pairs of peak value (maximum value) level and frequency data are calculated for voltage, current, and power, starting with the highest level and proceeding in order. In FFT calculation results, a value is considered to be a peak value if the levels for both adjacent values are lower.

Flicker measurement (to be supported in ver. 2.00)

Measurement channels	Max. 8 channels
Measurement method	IEC 61000-4-15:2010 compliant
Measured parameters	Short-term flicker (Pst) Short-term flicker maximum value (PstMax) Long-term flicker (Plt) Instantaneous flicker maximum value (PinstMax) Instantaneous flicker minimum value (PinstMin) Relative steady voltage change (dc) Maximum relative voltage change (dmax) Time for which the relative voltage change exceeded the threshold (Tmax)
Measurement frequency	50/60 Hz (measured only in IEC mode)

Motor Analysis (Option)

(PW8001-11, -12, -13, -14, -15, -16 only)

(1) Analog DC, frequency, pulse input shared specifications

Number of input channels	8 channels		
	CH	Input parameters	
	CH A, CH C, CH E, CH G	Analog DC, frequency, pulse	
Operating mode	CH B, CH D, CH F, CH H	frequency, pulse	
	Motor analysis mode		
		Measured or detected parameters (input waveforms)	Maximum no. of analyzed motors
	Pattern 1	Torque (analog/freq.), speed (pulse)	4 motors
	Pattern 2	Torque (analog/freq.), speed (pulse), direction, origin(pulse)	2 motors
Pattern 3	Torque (analog/freq.), speed (pulse), direction	2 motors	
Pattern 4	Torque (analog/freq.), speed (pulse), origin (pulse)	2 motors	
Pattern 5	Torque (analog/freq.), speed (analog)	2 motors	
	Individual input, modes CH A, CH C, CH E, and CH G: DC voltage measurement, frequency measurement CH B, CH D, CH F, and CH H: frequency measurement		
Input terminal profile	Isolated BNC connectors		
Input method	Function-isolated input and single-end input, functional isolation between channels		
Input resistance (DC)	1 MΩ ±50 kΩ		
Maximum input voltage	20 V		
Maximum rated line-to-ground voltage	50 V (50/60 Hz)		
Measurement parameters	Voltage, torque, RPM, frequency, slip, motor power		
Synchronization source	Same as described in "Voltage, current, and power measurement shared specifications" in the basic specifications.		
Measurement lower limit frequency	Select from the following frequencies for each motor synchronization source: 0.1 Hz, 1 Hz, 10 Hz, 100 Hz		
Measurement upper limit frequency	Select from the following frequencies for each motor synchronization source: 100 Hz, 500 Hz, 1 kHz, 5 kHz, 10 kHz, 50 kHz, 100 kHz, 500 kHz, 1 MHz, 2 MHz		
Input frequency source	Select from fU1 to fU8 or fI1 to fI8. Set frequency for slippage calculations.		
No. of motor poles	2 to 254		
Z-phase pulse detection reference	Set reference for detecting synchronization source's Zph when using the pattern 2 or pattern 4 operating mode. Rising edge/falling edge		
(2) Analog DC input (CH A, CH C, CH E, CH G)			
Measurement range	1 V, 5 V, 10 V		
Crest factor	1.5		
Effective input range	1% to 110% of range		
Sampling	1 MHz, 16-bit		
LPF	1 kHz, OFF (20 kHz)		

Response speed	0.2 ms (when LPF is OFF)
Measurement method	Simultaneous digital sampling, zero-cross synchronization calculation method (averaging between zero-crosses)
Measurement accuracy	±0.03% of reading ± 0.03% of range
Effects of temperature	Add the following within the range of 0°C to 20°C or 26°C to 40°C: ±0.01% of reading/°C ±0.01% of range/°C
Effects of commonmode voltage	±0.01% f.s. or less with 50 V applied between the input terminals and the enclosure (DC or 50/60 Hz)
Effects of external magnetic fields	±0.1% of range or less (in magnetic field of 400 A/m DC or 50/60 Hz)
Display range	0 to ±150%
Scaling	±(0.01 to 9999.99)(torque) / ±(0.00001 to 99999.9) (rpm)
Zero-adjustment	Zero correction of scaled input offset at or below ±10% of range. When torque meter correction is enabled, zero correction is performed by adding the correction value.
Torque meter correction	OFF/ON Nonlinear correction: Torque values are corrected using a correction table with up to 11 points, each of which is defined as the torque meter's measured value [N·m] and the corresponding torque correction value [N·m]. Linear interpolation is used between torque calibration values.
	Friction correction: Torque values are corrected using a correction table with up to 11 points, each of which is defined as an rpm value (including direction) [r/min.] and the corresponding torque correction value [N·m]. Linear interpolation is performed between torque calibration values.
Torque calculations and correction	- Correction table units are set by the user. - Correction values are input using 6 digits. - The torque calculation sign is used to detect positive (+) and reverse (-) rotation.
	OFF: torque value = S × (X - zero correction value) ON: torque value = S × (X - zero correction value) - At - Bt S: scaling X: input signal - torque conversion value At: nonlinear correction value Bt: friction correction value
(3) Frequency input (CH A, CH B, CH C, CH D, CH E, CH F, CH G, CH H)	
Detection level	Low: approx. 0.8 V or less, high: approx. 2.0 V or more
Measurement frequency band	0.1 Hz to 2 MHz (at 50% duty ratio)
Minimum detection width	0.25 μs or more
Measurement range	User sets the fc ±fd (Hz) zero-point frequency fc and the rated torque frequency fd. Both fc and fd must be within the range of 1 kHz to 500 kHz. Values are set in 0.01 Hz increments. However, fc + fd ≤ 500 kHz and fc - fd ≥ 1 kHz.
Measurement accuracy	±0.01% of reading Add 0.01% of reading at a 1 ms data update rate.
Display range	1.000 kHz to 500.000 kHz
Scaling	±0.01 to 9999.99
Zero-adjustment	Input offset is subject to zero correction within the range fc ± 1kHz. When torque meter correction is enabled, zero correction is performed by adding the correction value.
Units	mN · m, N · m, kN · m
Torque meter correction	Same as torque meter correction with analog DC input
Torque calculations and correction	Same as torque meter correction with analog DC input
(4) Pulse input (CH A, CH B, CH C, CH D, CH E, CH F, CH G, CH H)	
Detection level	Low: approx. 0.8 V or less, high: approx. 2.0 V or more
Measurement frequency band	0.1 Hz to 2 MHz (at 50% duty ratio)
Minimum detection width	0.25 μs or more

Pulse filter	OFF, Weak, Strong (When using the weak setting, positive and negative pulses of less than 0.25 μs are ignored. When using the strong setting, positive and negative pulses of 5 μs are ignored.)
Measurement range	2 MHz
Measurement accuracy	±0.01% of reading Add 0.01% of reading at a 1 ms data update rate.
Display range	0.1 Hz to 2.00000 MHz
Unit	Hz, r/min.
Frequency division setting range	1 to 60000
Rotation direction detection	[A-D] and [E-H] are set separately by the user. Motor analysis mode patterns 2 through 5 [A-D] is detected based on lead/lag of CH B and CH C. [E-H] is detected based on lead/lag of CH F and CH G.
Mechanical angle origin detection	[A-D] and [E-H] are set separately by the user. Motor analysis mode patterns 2 through 5 For [A-D], CH B division is cleared at the CH D rising edge or falling edge. For [E-H], CH F division is cleared at the CH H rising edge or falling edge.

Waveform & D/A output (Option)

(PW8001-02, -05, -12, -15 only)

Number of output channels	20 channels
Output terminal profile	D-sub 25-pin connector × 1
Output details	Switchable between waveform output and analog output (select from basic measurement parameters).
D/A conversion resolution	16 bits (polarity + 15 bits)
Output refresh rate	Waveform output: 1 MHz Analog output: 10 ms, 50 ms, 200 ms (based on data update rate for the selected parameter, ±1 ms relative to the output refresh rate)
Output voltage	Waveform output: switchable between ±2 V f.s. and ±1 V f.s., crest factor of 2.5 or greater. Setting applies to all channels Analog output: DC ±5 V f.s. (max. approx. ±12 V DC)
Output resistance	100 Ω ±5 Ω
Output accuracy	Waveform output: (±2 V f.s.) measurement accuracy ±0.5% f.s. (±1 V f.s.) measurement accuracy ±1.0% f.s. (defined for DC to 50 kHz) Analog output: output parameters measurement accuracy ±0.2% f.s.
Temperature coefficient	±0.05% f.s. / °C

Display section

Display characters	English, Japanese, Chinese (simplified)
Display	10.1-inch WXGA touch panel LCD display (1280 × 800 dots)
Dot pitch	0.1695 (V) mm × 0.1695 (H) mm
Display value resolution	999999 count (including integration values)
Display refresh rate	Measured values: approx. 200 ms (independent of internal data update rate) Waveforms: based on waveform record settings
Screens	Measurement screen, input settings screen, system settings screen, file operations screen

Instrument controls

Control devices	Power button × 1, rubber key × 23, rotary knob × 2, touch panel
Touch panel	Projection-type capacitive touch panel

External interface

(1) USB flash drive interface	
Connector	USB Type A receptacle connector × 1
Electrical specifications	USB 3.0 (SuperSpeed)
Connected device	USB flash drive
Recorded data	Save/load settings files Save measured values or automatically recorded data Save waveform data, save screenshots
(2) LAN interface	
Connector	RJ-45 connector × 1
Electrical specifications	IEEE802.3 compliant
Transmission method	100BASE-TX/1000BASE-T (automatic detection)
Protocol	TCP/IP (with DHCP function)
Functions	HTTP server (remote operations) Dedicated port (data transferring, command control) FTP server (file transferring) FTP client Modbus/TCP server
(3) GP-IB interface	
Connector	Micro-ribbon 24-pin connector × 1
Electrical specifications	IEEE 488.1 1987 compliant developed with reference to IEEE 488.2 1987
Addresses	00 to 30
Remote control	REMOTE/LOCAL key illuminates in remote state; canceled with REMOTE/LOCAL key.
Functions	Command control
(4) RS-232C interface	
Connector	D-sub 9-pin connector × 1, 9 pin, also used for external control
Electrical specifications	RS-232C, EIA RS-232D, CCITT V.24, and JIS X5101 compliant Full duplex, start stop synchronization, data length of 8, no parity, 1 stop bit
Flow control	None
Communications speed	9600 bps, 19200 bps, 38400 bps, 57600 bps, 115200 bps
Functions	Switching between command control and external control (simultaneous use not supported)
(5) External control interface	
Connector	D-sub 9-pin connector × 1, also used for RS-232C
Pin assignments	No. 1 pin: start/stop No. 4 pin: hold No. 5 pin: GND No. 6 pin: data reset
Electrical specifications	0/5 V (2.5 V to 5 V) logic signals or contact signals with terminal shorted or open.
Functions	Same operation as START/STOP, HOLD, or DATA RESET key on instrument panel. Switching with RS-232C (simultaneous use not supported)

(6) Optical link interface (Option) PW8001-04, -05, -06, -14, -15, -16 only (to be supported in ver. 2.00)	
Number of instruments that can be synchronized	2 (1 primary, 1 secondary)
Optical signal	850 nm VCSEL, 1 Gbps
Laser classification	Class 1
Type of fiber	50/125 μm multi-mode fiber equivalent, up to 500 m
Functionality	<p>Primary instrument</p> <ul style="list-style-type: none"> • Display of received secondary instrument measured values (calculation measurement parameters and flicker measurement parameters, up to 50th-order frequency) • Display and modification of [WIRING], [CHANNEL], and [MOTOR] settings on secondary instrument • Configuration of secondary instrument's phase zero adjustment function ([VECTOR × 1] screen) • Display of setup for secondary instrument units and connected current sensors ([CONFIG] screen) <p>Secondary instrument</p> <ul style="list-style-type: none"> • Synchronization of internal calculation and data refresh timing with primary instrument • Transmission of some measurement data to primary instrument • Application of some primary instrument settings • The following operations are not supported when using the optical link: <ol style="list-style-type: none"> 1. Modification of settings, with the exception of certain settings related to functionality such as optical link, communications, and language 2. Starting and stopping of integration, and resetting of integrated data 3. Output of CAN signals 4. Instrument operations initiated by the HOLD, PEAK HOLD, COPY, and SAVE keys <p>Data synchronization is not supported when the data refresh rate is 10 ms or less. Synchronization is not supported when the primary instrument is in IEC measurement mode. The optical link and BNC synchronization cannot be selected at the same time.</p>
(7) BNC sync. interface (to be supported in ver. 2.00)	
Connector	BNC
Number of instruments that can be synchronized	4 (1 primary, 3 secondary)
Operating mode	Timing synchronization
Functionality	<p>Primary instrument</p> <p>Transmission of control signals to the secondary instrument</p> <p>Secondary instrument</p> <p>Synchronization of the following functions and operations with the primary instrument:</p> <ul style="list-style-type: none"> • Internal calculations and data refresh timing • Starting and stopping of integration, and resetting of integrated data • Display hold (initiated by the HOLD or PEAK HOLD key) and data refresh during hold operation • Zero adjustment • Instrument operations initiated by the SAVE or COPY keys • Current time <p>(Synchronized information cannot be controlled, or associated settings changed, during synchronization.) Synchronization is only supported when the primary and secondary instruments are set to the same measurement mode and data refresh rate.</p> <p>Data synchronization is not supported when the data refresh rate is 10 ms or less. The optical link and BNC synchronization cannot be selected at the same time.</p>

(8) CAN/CAN FD (Option) PW8001-03, -06, -13, -16 only	
Protocol	CAN (classical), CAN FD (compliant with ISO 11898-1:2015), CAN FD (non-compliant with ISO)
Functionality	Output of specified data from basic measured parameters
CAN ports	1
No. of installed units	1 (exclusive with D/A output unit option)
Baud rate	CAN: 125 kbps, 250 kbps, 500 kbps, 1 Mbps CAN FD: arbitration region, 500 kbps, 1 Mbps (data region: 500 kbps, 1 Mbps, 2 Mbps, 4 Mbps)
Format	Standard/Extended
Data frame output	Continuous
Continuous	Output intervals: 1 ms, 10 ms, 50 ms, 100 ms, 200 ms, 500 ms, 1 s, 5 s, 10 s, 15 s, 30 s, 1 min, 5 min, 10 min, 15 min, 30 min, 60 min (±1 ms for each output interval setting) No. of repeated outputs: 0 to 10000 (0: unlimited)
Communications connector	D-sub 9-pin connector (male connector) Lockscrew (hexagonal post): inch thread #4-40 UNC
Terminal resistance	ON/OFF Resistance: 120 Ω ± 10 Ω

Functional specifications

AUTO-range function

Functions	The voltage and current ranges for each wiring method are automatically changed in response to the input (except motor input range)
Operating mode	OFF/ON (selectable for each wiring method)

Time control function

Functions	Auto-saving and integration measurement are controlled based on the time.
Operation	Timer control: auto-saving and integration measurement are stopped automatically once the timer control time has elapsed. Actual time control: auto-saving and integration measurement are started and stopped based on user-specified times.
Timer control	OFF, 1 sec. to 9999 hr. 59 min. 59 sec. (in 1 sec. increments)
Actual time control	OFF, start/stop time (in 1 sec. increments)

Hold function

(1) Hold	
Functions	Display updates are stopped for all measured values, causing the display to be locked to its current contents. However, display updates continue for waveforms, time, and peak-exceeded events. Internal calculations such as integration and averaging continue. It cannot be combined with the peak hold function.
Output data	Hold data is output for analog output and save data during peak hold operation (however, waveform output continues)
(2) Peak hold	
Functions	The display is updated with maximum values based on an absolute value comparison for each measured value (except Upk and Ipk). However, instantaneous value display updates continue for waveform displays and integrated values. During averaging, absolute values are used as post-averaging measured values. Cannot be combined with the hold function.
Output data	Peak hold data is output for analog output and save data during peak hold operation. However, waveform output continues.

Calculation function

(1) Rectifier	
Functions	Selects the voltage and current values used to calculate apparent and reactive power and power factors.
Operating mode	RMS/mean (can be selected for each wiring method's voltage and current)
(2) Scaling	
Functions	The VT ratio and CT ratio are set for each channel and applied to measured values.
VT (PT) ratio	Set by each connections, OFF, 0.00001 to 9999.99 (values cannot be set such that VT × CT exceeds 1.0E+06.)
CT ratio	Set by each channels, OFF, 0.00001 to 9999.99 (values cannot be set such that VT × CT exceeds 1.0E+06.)

(3) Averaging (AVG)				
Functions	All instantaneous measured values, including harmonics, are averaged. (except peak values, integrated values, and harmonic data updated every 10 ms. when the data update rate is set to 1 ms, all averaging is not performed.)			
Operating mode	OFF, exponential averaging, moving average			
Exponential averaging response rate	Number of averaging iterations	FAST	MID	SLOW
	10 ms	0.1 s	0.8 s	5 s
	50 ms	0.5 s	4 s	25 s
	200 ms	2.0 s	16 s	100 s
These values indicate the time required for the final stabilized value to converge on ±1% when the input changes from 0% f.s. to 90% f.s. Although harmonic data is not averaged when the data refresh rate is 10 ms, harmonic data included in basic measurement parameters is averaged using an indexation average coefficient every 10 ms.				
No. of moving average iterations	8, 16, 32, 64 times			

(4) Efficiency and loss calculations	
Functions	Efficiency η (%) and loss (W) are calculated for the wiring method's active power period for each channel.
Calculated items	Active power value (P), fundamental wave active power (Pfund), and motor power (Pm)* *PW8001-11, -12, -13, -14, -15, -16 only
Number of calculations that can be performed	4 each for efficiency and loss
Modes	Fixed mode: The position of terms set on the input and output sides of equations is fixed, regardless of the measured values. Auto mode: The position of terms set on the input and output sides is switched depending on the sign of the measured values.
Equations	Fixed mode: Terms are specified for Pin(n) and Pout(n) Pin = Pin1 + Pin2 + Pin3 + Pin4 + Pin5 + Pin6 Pout = Pout1 + Pout2 + Pout3 + Pout4 + Pout5 + Pout6 $\eta = 100 \times \text{IPout} / \text{IPin}$, Loss = IPinI - IPoutI Auto mode: Pin = (Sum of the absolute values of input/positive terms and output/negative terms) Pout = (Sum of the absolute values of output/positive terms and input/negative terms) $\eta = 100 \times \text{IPout} / \text{IPin}$, Loss = IPinI - IPoutI

(5) User-defined calculations	
Functions	User-specified basic measurement parameters are calculated using the specified calculation formulas. Calculations are not supported when the data refresh rate is set to 1 ms.
Calculation terms	Up to 16 terms (basic measurement parameters or constants of up to 6 digits) Operators: 4 basic operators UDFn = ITEM1 □ ITEM2 □ ITEM3 □ ITEM4 □ ... □ ITEM16 ITEMn: Basic measurement parameters (including UDFn) or constants of up to 6 digits □: One of +, -, *, or / Function of ITEMn: neg (sign), sin, cos, tan, abs, log10 (common logarithm), log (logarithm), exp, sqrt, asin, acos, atan, sqr UDFn is calculated in the order of n; if a UDFn with an n value greater than the function's own n value is selected, the instrument uses the previous calculated value.
Number of equations	20 (UDF1 to UDF20)

Maximum value setting	Fixed / Auto Set for each UDFn Fixed: Set within range of 1.000n to 999.999T Auto: Upper 6 digits are displayed at all times. (Effective display range: 0 to ±999.999T) Maximum values operate as a UDFn range.
UDF names and units	Up to 8 ASCII characters for each UDFn
Integration	OFF/ON Set for each UDFn OFF: Displays the UDFn calculated value. ON: Displays the integrated value using the UDFn equation as UDFn. (Effective display range: 0 to ±99.9999P) Integration stops once the integrated value exceeds the effective display range.

(6) Delta conversion	
Functions	Δ -Y When using a 3P3W3M or 3V3A wiring method, it converts the line voltage waveform to a phase voltage waveform using a virtual neutral point.
	Y- Δ When using a 3P4W wiring method, it converts the phase voltage waveform to a line voltage waveform. Voltage RMS values and all voltage parameters, including harmonics, are calculated using the post-conversion voltage. However, peak-exceeded events are judged using pre-conversion values.

(7) Power formula selection	
Functions	Selects the reactive power, power factor, and power phase angle formulas.
Formula	TYPE1/TYPE2/TYPE3 TYPE1: Compatible with the type 1 equations of the PW3390, 3193, and 3390. TYPE2: Compatible with the type 2 equations of the 3192 and 3193. TYPE3: Uses the active power sign as the power factor sign. (Type 1, type 2, and type 3 are compatible with each the respective calculation equation types of the PW6001.)

(8) Current sensor phase shift calculation	
Functions	Compensates the current sensor's harmonic phase characteristics using calculations.
Operating modes	AUTO/OFF/ON (set by channel) Auto mode can be selected when a current sensor supporting the automatic detection function is connected.
Compensation value settings	Compensation points are set using the frequency and phase difference. Frequency: 0.1 kHz to 5000.0 kHz (in 0.1 kHz steps) Phase difference: 0.000° to ±180.000° (in 0.1° steps) When using the auto-operating mode, settings are done automatically when the sensor is connected.
Max. correction range	U7005: approx. 9.4 μ s U7001: approx. 15.8 μ s

(9) Voltage probe phase shift calculation	
Functions	Compensates the voltage probe's harmonic phase characteristics using calculations.
Operating modes	OFF/ON (set by channel)
Compensation value settings	Compensation points are set using the frequency and phase difference. Frequency: 0.1 kHz to 5000.0 kHz (in 0.1 kHz steps) Phase difference: 0.000 deg to ±180.000 deg (in 0.001 deg steps)
Max. correction range	U7005: approx. 9.4 μ s U7001: approx. 15.8 μ s

Display function

(1) Wiring method confirmation screen	
Functions	Displays a wiring diagram, and voltage and current vectors based on the selected measurement lines. The ranges for a correct wiring method are displayed on the vector display so that the wiring can be checked.
Mode at startup	Users can select to display the wiring confirmation screen at startup (startup screen setting).
Simple settings	The instrument switches to appropriate settings when the measurement target is selected for each connection. 50/60Hz, DC/WLTP, PWM, HIGH FREQ, GENERAL.
(2) Vector display screen	
Functions	Displays a connection-specific vector graph along with associated level values and phase angles.
Display patterns	1-vector: renders vectors for up to 8 channels. 2-/4-vector: renders vectors for each selected wiring method.
(3) Numerical display screen	
Functions	Displays measured power values and measured motor values for up to 8 instrument channels.
Display patterns	Basic by wiring method: Displays measured values for the measurement lines and motors combined in the wiring. There are four measurement line patterns: U, I, P, and Integ. Display selection: The user can create a numerical display in which the user's desired basic measurement parameters is in the user's desired location of the screen. There are 8-, 16-, 36-, and 64-display patterns.
(4) Harmonic display screen	
Functions	Displays measured harmonic values on the instrument's screen. Display bar graph: Displays harmonic measurement parameters for user-specified channels as a bar graph (max. 500th order) Display list: Displays numerical values for user-specified parameters and user-specified channels.
Display patterns	
(5) Waveform display screen	
Functions	Displays the voltage and current waveforms and motor waveforms.
Display patterns	All-waveform display, waveform + numerical display

Automatic data save function

Functions	Saves the user-specified measured values every user-specified interval
Save destination	OFF, USB flash drive
Saved parameters	The user can select it from all measured values, including harmonic measured values Automatic saving of harmonic data is not supported when the data refresh rate is set to 1 ms.
Interval	OFF, 1 ms, 10 ms, 50 ms, 100 ms, 200 ms, 500 ms, 1 s, 5 s, 10 s, 15 s, 30 s, 1 min, 5 min, 10 min, 15 min, 30 min, 60 min However, it is not possible to set less than the data update rate.
Max. savable data	Approx. 500 MB per file (automatically segmented) × 1000 files
Data format	CSV Comma (,) as the measurement data delimiter and period (.) as the decimal point SSV Semicolon (;) as the measurement data delimiter and comma (,) as the decimal point BIN Shared file format that can be loaded by GENNECT One
Filename	Automatically created based on start time and date.

Manual data save function

(1) Measurement data	
Functions	Measured values are saved when the SAVE key is pressed. Data is output to the same file until the settings are changed or until the DATA RESET key is pressed.
Save destination	USB flash drive
Saved parameters	User-selected from all measured values, including harmonic measured values
Max. save data	Approx. 500 MB per file (automatically segmented)
Data format	CSV, SSV
(2) Waveform data	
Functions	Waveforms are saved in the set format when the [Save] button on the touch panel in the wave screen is touched.
Save destination	USB flash drive
Saved parameters	Waveform data shown on waveform screen
Max. save data	Approx. 400 MB (binary) or approx. 2 GB (In text format)
Data format	CSV, SSV, BIN, MAT (file format for MATLAB)
(3) FFT data	
Functions	FFT calculation results data is saved when the user taps the "Save" button on the [WAVEFORM + FFT] screen's touch panel.
Save destination	USB flash drive
Saved parameters	FFT data shown on waveform and FFT screen
Max. save data	Approx. 112 MB (In text format) 1,000,000 data per file (automatically segmented)
Data format	CSV, SSV
(4) Screenshots	
Functions	Screenshots are saved when the COPY key is pressed. A settings list can be added to the screenshot Comment addition function Touch-pen or finger drawings can be added to the screenshot
Save destination	USB flash drive
Saved parameters	Screen data
Data format	PNG
(5) Settings data	
Functions	Settings information can be saved as a settings file on the FILE screen. Settings files saved on the FILE screen can be loaded and restored. This functionality does not include language and communications settings. Settings data includes an image depicting a list of the settings, which can be opened in an image viewer.
Save destination	USB flash drive, FTP Servers
Saved parameters	Settings data
Data format	SET
(6) CAN output settings data	
Functions	Data output settings on the CAN OUTPUT screen are saved as a DBC file.
Save destination	USB flash drive, FTP Servers
Saved parameters	Output settings data
Data format	DBC
(7) User-defined equation data	
Functions	User-defined equations set on the UDF screen are saved as a JSON file. JSON files saved on the UDF or FILE screen can be loaded and their equations restored. If a loaded equation contains invalid terms (terms that cannot be selected due to the unit, option configuration, or other settings), the calculation will not be performed (the display will show [----]).
Save destination	USB flash drive, FTP Servers
Saved parameters	User-defined equations
Data format	JSON

Other functions

Clock function	Auto-calendar, automatic leap year detection, 24-hour clock
Actual time accuracy	When the instrument is ON, ±100 ppm When the instrument is off, within ±3 sec./day (25°C)
Sensor identification	Current sensors connected to probe 1 are automatically detected. Correction values are automatically applied if the current sensor has phase correction data.
Zero suppression function	Select from "off" and "on" (0.5% f.s.). When set to "on," measurement parameters whose values are less than 0.5% of full scale are replaced by the value 0.





Environment and safety specifications

Operating environment	Indoors at an elevation of up to 2000 m in a Pollution Level 2 environment
Operating temperature and humidity	0°C to 40°C, 80% RH or less (no condensation)
Storage temperature and humidity	-10°C to 50°C, 80% RH or less (no condensation)
Dustproofness, water-proofness	IP20 (EN 60529)
Standards	Safety: EN61010 EMC: EN61326 Class A
Power supply	Grid power Rated supply voltage: 100 to 240 V AC (assuming voltage fluctuations of ±10% relative to rated supply voltage) Rated power supply frequency: 50 Hz, 60 Hz Anticipated transient overvoltage: 2500 V Max. rated power: 230 VA
Backup battery life	Lithium battery: approx. 10 years (23°C reference value) Backup contents: time and setting conditions
Dimensions	Approx. 430W × 221H × 361D mm (16.93 in. W × 8.70 in. H × 14.21 in. D) (excluding protruding parts)
Weight	Approx. 14 kg (493.84 oz.) (reference value with unit mounted)
Product warranty period	3 year

Overview of supported current sensors and specifications

High-accuracy pass-through current sensors

Product warranty period: 3 year Guaranteed accuracy period: 1 year

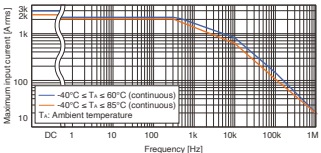
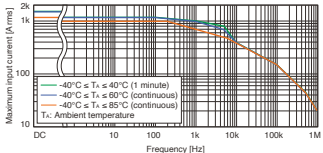
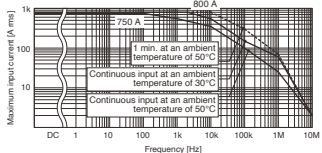
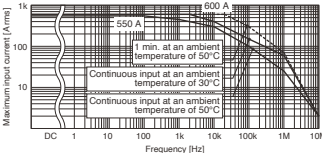
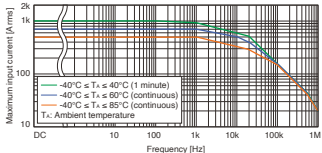



Model		CT6877A, CT6877A-1	CT6876A, CT6876A-1	CT6904A-2*1, CT6904A-3*1	CT6904A, CT6904A-1*1	CT6875A, CT6875A-1				
Appearance										
Rated current		2000 A AC/DC	1000 A AC/DC	800 A AC/DC	500 A AC/DC	500 A AC/DC				
Frequency band		DC to 1 MHz	CT6876A: DC to 1.5 MHz CT6876A-1: DC to 1.2 MHz	CT6904A-2: DC to 4 MHz CT6904A-3: DC to 1.2 MHz	CT6904A: DC to 4 MHz CT6904A-1: DC to 2 MHz	CT6875A: DC to 2 MHz CT6875A-1: DC to 1.5 MHz				
Diameter of measurable conductors		Max. φ 80 mm (3.14 in.)	Max. φ 36 mm (1.41 in.)	Max. φ 32 mm (1.25 in.)	Max. φ 32 mm (1.25 in.)	Max. φ 36 mm (1.41 in.)				
Accuracy	U7001 Combined*2	Current (I)	DC : ±0.06% ±0.058%	DC : ±0.06% ±0.058%	U7001 accuracy + Sensor accuracy	U7001 accuracy + Sensor accuracy	DC : ±0.06% ±0.058%			
		Active power (P)	45 Hz ≤ f ≤ 66 Hz : ±0.06% ±0.058%	45 Hz ≤ f ≤ 66 Hz : ±0.06% ±0.058%			45 Hz ≤ f ≤ 66 Hz : ±0.06% ±0.058%			
			DC : ±0.06% ±0.058%	DC : ±0.06% ±0.058%			DC : ±0.06% ±0.058%			
		U7005 Combined*2	Current (I)	DC : ±0.06% ±0.038%			DC : ±0.06% ±0.038%	DC : ±0.05% ±0.037%	DC : ±0.045% ±0.037%	DC : ±0.06% ±0.038%
			Active power (P)	45 Hz ≤ f ≤ 66 Hz : ±0.05% ±0.028%			45 Hz ≤ f ≤ 66 Hz : ±0.05% ±0.028%	45 Hz ≤ f ≤ 66 Hz : ±0.035% ±0.027%	45 Hz ≤ f ≤ 66 Hz : ±0.03% ±0.027%	45 Hz ≤ f ≤ 66 Hz : ±0.05% ±0.028%
				DC : ±0.06% ±0.038%			DC : ±0.06% ±0.038%	DC : ±0.05% ±0.037%	DC : ±0.045% ±0.037%	DC : ±0.06% ±0.038%
	Sensor only (amplitude)*3		DC	: ±0.04% ±0.008%	DC	: ±0.04% ±0.008%	DC	: ±0.025% ±0.007%	DC	: ±0.04% ±0.008%
			DC < f < 16 Hz	: ±0.1% ±0.02%	DC < f < 16 Hz	: ±0.1% ±0.02%	DC < f < 16 Hz	: ±0.2% ±0.025%	DC < f < 16 Hz	: ±0.2% ±0.02%
			16 Hz ≤ f < 45 Hz	: ±0.05% ±0.01%	16 Hz ≤ f < 45 Hz	: ±0.05% ±0.01%	16 Hz ≤ f < 45 Hz	: ±0.1% ±0.025%	16 Hz ≤ f < 45 Hz	: ±0.1% ±0.02%
		45 Hz ≤ f ≤ 66 Hz	: ±0.04% ±0.008%	45 Hz ≤ f ≤ 66 Hz	: ±0.04% ±0.008%	45 Hz ≤ f ≤ 66 Hz	: ±0.025% ±0.009%	45 Hz ≤ f ≤ 66 Hz	: ±0.04% ±0.008%	
		66 Hz < f ≤ 100 Hz	: ±0.05% ±0.01%	66 Hz < f ≤ 100 Hz	: ±0.05% ±0.01%	65 Hz < f ≤ 850 Hz	: ±0.05% ±0.009%	65 Hz < f ≤ 850 Hz	: ±0.05% ±0.007%	
		100 Hz < f ≤ 500 Hz	: ±0.1% ±0.02%	100 Hz < f ≤ 500 Hz	: ±0.1% ±0.02%	850 Hz < f ≤ 1 kHz	: ±0.1% ±0.013%	850 Hz < f ≤ 1 kHz	: ±0.1% ±0.01%	
		500 Hz < f ≤ 1 kHz	: ±0.2% ±0.02%	500 Hz < f ≤ 1 kHz	: ±0.2% ±0.02%	1 kHz < f ≤ 5 kHz	: ±0.4% ±0.025%	1 kHz < f ≤ 5 kHz	: ±0.4% ±0.02%	
		1 kHz < f ≤ 10 kHz	: ±0.5% ±0.02%*5	1 kHz < f ≤ 10 kHz	: ±0.5% ±0.02%*5	5 kHz < f ≤ 10 kHz	: ±0.4% ±0.025%	5 kHz < f ≤ 10 kHz	: ±0.4% ±0.02%	
		10 kHz < f ≤ 50 kHz	: ±1.5% ±0.05%*5	10 kHz < f ≤ 50 kHz	: ±2% ±0.05%*5	10 kHz < f ≤ 50 kHz	: ±1% ±0.025%	10 kHz < f ≤ 50 kHz	: ±1.5% ±0.05%*5	
		50 kHz < f ≤ 100 kHz	: ±2.5% ±0.05%*5	50 kHz < f ≤ 100 kHz	: ±3% ±0.05%*5	50 kHz < f ≤ 100 kHz	: ±1% ±0.063%*6	50 kHz < f ≤ 100 kHz	: ±2.5% ±0.05%*5	
		100 kHz < f ≤ 700 kHz	: ±(0.025x f) ±0.05%*5	100 kHz < f ≤ 1 MHz	100 kHz < f ≤ 1 MHz	100 kHz < f ≤ 300 kHz	: ±2% ±0.063%*6	100 kHz < f ≤ 300 kHz	: ±2% ±0.05%*5	
		-	-	-	-	300 kHz < f ≤ 1 MHz	: ±5% ±0.063%*6	300 kHz < f ≤ 1 MHz	: ±5% ±0.05%*5	
Common-Mode Rejection Ratio (CMRR)		140 dB or greater (50/60 Hz) 120 dB or greater (100 kHz) (effect on output voltage and common mode voltage)	140 dB or greater (50/60 Hz) 120 dB or greater (100 kHz) (effect on output voltage and common mode voltage)	140 dB or greater (50/60 Hz) 120 dB or greater (100 kHz) (effect on output voltage and common mode voltage)	140 dB or greater (50/60 Hz) 120 dB or greater (100 kHz) (effect on output voltage and common mode voltage)	140 dB or greater (50/60 Hz) 120 dB or greater (100 kHz) (effect on output voltage and common mode voltage)				
Linearity errors (typical)		±10 ppm	±5 ppm	±12.5 ppm	±5 ppm	±5 ppm				
Offset errors (typical)		±5 ppm	±5 ppm	±10 ppm	±10 ppm	±5 ppm				
Amplitude errors (typical)		(DC) ±15 ppm, (10 to 100 Hz) ±0.01%, (100 Hz to 1 kHz) ±0.04%, (1 k to 10 kHz) ±0.25%, (10 k to 100 kHz) ±1%, (100 k to 300 kHz) ±2%, (300 kHz to 700 kHz) ±10%	(DC) ±10 ppm, (10 to 100 Hz) ±0.005%, (100 Hz to 1 kHz) ±0.03%, (1 k to 10 kHz) ±0.2%, (10 k to 100 kHz) ±1%, (100 k to 300 kHz) ±3%, (300 kHz-1 MHz) ±15%,	-	-	(DC) ±10 ppm, (10 to 100 Hz) ±0.005%, (100 Hz to 1 kHz) ±0.02%, (1 k to 20 kHz) ±0.08%, (20 k to 100 kHz) ±0.5%, (100 k to 300 kHz) ±1%, (300 Hz to 1 MHz) ±5%				
Frequency derating										
Output voltage		1 mV/A (= 2 V / 2000 A)	2 mV/A (= 2 V / 1000 A)	2 mV/A (= 2 V / 1000 A)	4 mV/A (= 2 V / 500 A)	4 mV/A (= 2 V / 500 A)				
Operating temperature and humidity*4		-40°C to 85°C (-40°F to 185°F), 80% RH or less	-40°C to 85°C (-40°F to 185°F), 80% RH or less	-10°C to 50°C (-14°F to 122°F), 80% RH or less	-10°C to 50°C (-14°F to 122°F), 80% RH or less	-40°C to 85°C (-40°F to 185°F), 80% RH or less				
Storage temperature and humidity*4		-40°C to 85°C (-40°F to 185°F), 80% RH or less	-40°C to 85°C (-40°F to 185°F), 80% RH or less	-20°C to 60°C (-4°F to 140°F), 80% RH or less	-20°C to 60°C (-4°F to 140°F), 80% RH or less	-40°C to 85°C (-40°F to 185°F), 80% RH or less				
Maximum rated voltage to earth		1000 V CATIII anticipated transient overvoltage: 8000 V	1000 V CATIII anticipated transient overvoltage: 8000 V	1000 V CATIII anticipated transient overvoltage: 8000 V	1000 V CATIII anticipated transient overvoltage: 8000 V	1000 V CATIII anticipated transient overvoltage: 8000 V				
Standards		Safety: EN 61010, EMC: EN 61326	Safety: EN 61010, EMC: EN 61326	Safety: EN 61010, EMC: EN 61326	Safety: EN 61010, EMC: EN 61326	Safety: EN 61010, EMC: EN 61326				
Cable length		CT6877A: approx. 3 m (9.84 ft.) CT6877A-1: approx. 10 m (32.81 ft.)	CT6876A: approx. 3 m (9.84 ft.) CT6876A-1: approx. 10 m (32.81 ft.)	CT6904A-2: approx. 3 m (9.84 ft.) (including relay box) CT6904A-3: approx. 10 m (32.81 ft.) (including relay box)	CT6904A: approx. 3 m (9.84 ft.) (including relay box) CT6904A-1: approx. 10 m (32.81 ft.) (including relay box)	CT6875A: approx. 3 m (9.84 ft.) CT6875A-1: approx. 10 m (32.81 ft.)				
Dimensions		Approx. 229W x 232H x 112D mm (approx. 9.02W x 9.13H x 4.41D in.)	Approx. 160W x 112H x 50D mm (approx. 6.30W x 4.41H x 1.97D in.)	Approx. 139W x 120H x 52D mm (approx. 5.47W x 4.72H x 2.05D in.)	Approx. 139W x 120H x 52D mm (approx. 5.47W x 4.72H x 2.05D in.)	Approx. 160W x 112H x 50D mm (approx. 6.30W x 4.41H x 1.97D in.)				
Weight		CT6877A: approx. 5 kg (176.4 oz.) CT6877A-1: approx. 5.3 kg (187.0 oz.)	CT6876A: approx. 0.97 kg (34.2 oz.) CT6876A-1: approx. 1.3 kg (45.9 oz.)	CT6904A-2: approx. 1.15 kg (40.6 oz.) CT6904A-3: approx. 1.45 kg (51.1 oz.)	CT6904A: approx. 1.05kg (37.0 oz.) CT6904A-1: approx. 1.35 kg (47.6 oz.)	CT6875A: approx. 0.8 kg (28.2 oz.) CT6875A-1: approx. 1.1 kg (38.8 oz.)				

*1: Build-to-order product *2: ±(% of reading + % of range), range is PW8001 *3: ±(% of reading + % of full scale), full scale is rated current of sensor *4: Non-condensing

*5: When 1 kHz < f ≤ 700 kHz (CT6877A-1), 1 kHz < f ≤ 1 MHz (CT6876A-1/CT6875A-1), add ±(0.005 × f [kHz])% of reading to amplitude accuracy *6: When 50 kHz < f ≤ 1 MHz (CT6904A-3, CT6904A-1), add ±(0.015 × f)% of reading to amplitude accuracy

High-accuracy pass-through current sensors



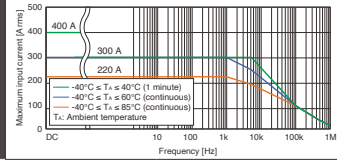
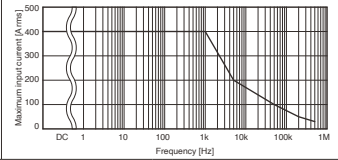
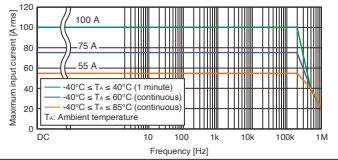
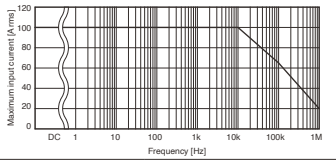

Product warranty period: 3 year Guaranteed accuracy period: 1 year

Model	CT6873, CT6873-01	CT6863-05	CT6872, CT6872-01	CT6862-05				
Appearance								
Rated current	200 A AC/DC	200 A AC/DC	50 A AC/DC	50 A AC/DC				
Frequency band	DC to 10 MHz	DC to 500 kHz	DC to 10 MHz	DC to 1 MHz				
Diameter of measurable conductors	Max. ϕ 24 mm (0.94 in.)	Max. ϕ 24 mm (0.94 in.)	Max. ϕ 24 mm (0.94 in.)	Max. ϕ 24 mm (0.94 in.)				
Accuracy	U7001 Combined*1	U7001 accuracy + Sensor accuracy	U7001 accuracy + Sensor accuracy	U7001 accuracy + Sensor accuracy				
					Current (I)	DC : $\pm 0.05\% \pm 0.052\%$ 45 Hz $\leq f \leq 66$ Hz : $\pm 0.05\% \pm 0.057\%$	DC : $\pm 0.05\% \pm 0.052\%$ 45 Hz $\leq f \leq 66$ Hz : $\pm 0.05\% \pm 0.057\%$	DC : $\pm 0.05\% \pm 0.052\%$ 45 Hz $\leq f \leq 66$ Hz : $\pm 0.05\% \pm 0.057\%$
					Active power (P)	DC : $\pm 0.05\% \pm 0.052\%$ 45 Hz $\leq f \leq 66$ Hz : $\pm 0.05\% \pm 0.057\%$	DC : $\pm 0.05\% \pm 0.052\%$ 45 Hz $\leq f \leq 66$ Hz : $\pm 0.05\% \pm 0.057\%$	DC : $\pm 0.05\% \pm 0.052\%$ 45 Hz $\leq f \leq 66$ Hz : $\pm 0.05\% \pm 0.057\%$
					U7005 Combined*1	U7005 accuracy + Sensor accuracy	U7005 accuracy + Sensor accuracy	U7005 accuracy + Sensor accuracy
	Current (I)	DC : $\pm 0.05\% \pm 0.032\%$ 45 Hz $\leq f \leq 66$ Hz : $\pm 0.04\% \pm 0.027\%$	DC : $\pm 0.05\% \pm 0.032\%$ 45 Hz $\leq f \leq 66$ Hz : $\pm 0.04\% \pm 0.027\%$	DC : $\pm 0.05\% \pm 0.032\%$ 45 Hz $\leq f \leq 66$ Hz : $\pm 0.04\% \pm 0.027\%$				
	Active power (P)	DC : $\pm 0.05\% \pm 0.032\%$ 45 Hz $\leq f \leq 66$ Hz : $\pm 0.04\% \pm 0.027\%$	DC : $\pm 0.05\% \pm 0.032\%$ 45 Hz $\leq f \leq 66$ Hz : $\pm 0.04\% \pm 0.027\%$	DC : $\pm 0.05\% \pm 0.032\%$ 45 Hz $\leq f \leq 66$ Hz : $\pm 0.04\% \pm 0.027\%$				
	Sensor only (amplitude)*2	DC : $\pm 0.03\% \pm 0.002\%$ DC < f ≤ 16 Hz : $\pm 0.1\% \pm 0.01\%$ 16 Hz < f ≤ 45 Hz : $\pm 0.05\% \pm 0.01\%$ 45 Hz < f ≤ 66 Hz : $\pm 0.03\% \pm 0.007\%$ 66 Hz < f ≤ 100 Hz : $\pm 0.04\% \pm 0.01\%$ 100 Hz < f ≤ 500 Hz : $\pm 0.05\% \pm 0.01\%$ 500 Hz < f ≤ 3 kHz : $\pm 0.1\% \pm 0.01\%$ 3 kHz < f ≤ 10 kHz : $\pm 0.2\% \pm 0.02\%$ 10 kHz < f ≤ 1 MHz : $\pm (0.018 \times f \text{ kHz})\% \pm 0.05\%$ -	DC : $\pm 0.05\% \pm 0.01\%$ DC < f ≤ 16 Hz : $\pm 0.10\% \pm 0.02\%$ 16 Hz < f ≤ 400 Hz : $\pm 0.05\% \pm 0.01\%$ 400 Hz < f ≤ 1 kHz : $\pm 0.2\% \pm 0.02\%$ 1 kHz < f ≤ 5 kHz : $\pm 0.7\% \pm 0.02\%$ 5 kHz < f ≤ 10 kHz : $\pm 1\% \pm 0.02\%$ 10 kHz < f ≤ 50 kHz : $\pm 2\% \pm 0.02\%$ 50 kHz < f ≤ 100 kHz : $\pm 5\% \pm 0.05\%$ 100 kHz < f ≤ 300 kHz : $\pm 10\% \pm 0.05\%$ 300 kHz < f ≤ 500 kHz : $\pm 30\% \pm 0.05\%$ -	DC : $\pm 0.03\% \pm 0.002\%$ DC < f ≤ 16 Hz : $\pm 0.1\% \pm 0.01\%$ 16 Hz < f ≤ 45 Hz : $\pm 0.05\% \pm 0.01\%$ 45 Hz < f ≤ 66 Hz : $\pm 0.03\% \pm 0.007\%$ 66 Hz < f ≤ 100 Hz : $\pm 0.04\% \pm 0.01\%$ 100 Hz < f ≤ 500 Hz : $\pm 0.06\% \pm 0.01\%$ 500 Hz < f ≤ 1 kHz : $\pm 0.1\% \pm 0.01\%$ 1 kHz < f ≤ 10 kHz : $\pm 0.15\% \pm 0.02\%$ 10 kHz < f ≤ 1 MHz : $\pm (0.012 \times f \text{ kHz})\% \pm 0.05\%$ -	DC : $\pm 0.05\% \pm 0.01\%$ DC < f ≤ 16 Hz : $\pm 0.10\% \pm 0.02\%$ 16 Hz < f ≤ 400 Hz : $\pm 0.05\% \pm 0.01\%$ 400 Hz < f ≤ 1 kHz : $\pm 0.2\% \pm 0.02\%$ 1 kHz < f ≤ 5 kHz : $\pm 0.7\% \pm 0.02\%$ 5 kHz < f ≤ 10 kHz : $\pm 1\% \pm 0.02\%$ 10 kHz < f ≤ 50 kHz : $\pm 1\% \pm 0.02\%$ 50 kHz < f ≤ 100 kHz : $\pm 2\% \pm 0.05\%$ 100 kHz < f ≤ 300 kHz : $\pm 5\% \pm 0.05\%$ 300 kHz < f ≤ 700 kHz : $\pm 10\% \pm 0.05\%$ 700 kHz < f < 1 MHz : $\pm 30\% \pm 0.05\%$			
	Common-Mode Rejection Ratio (CMRR)*3	150 dB or greater (DC to 1 kHz) 140 dB or greater (1 kHz to 10 kHz) 120 dB or greater (10 kHz to 100 kHz) 100 dB or greater (100 kHz to 1 MHz) (effect on output voltage and common mode voltage)	0.05% f.s. or less (1000 V rms, DC to 100 Hz)	150 dB or greater (DC to 1 kHz) 140 dB or greater (1 kHz to 10 kHz) 120 dB or greater (10 kHz to 100 kHz) 100 dB or greater (100 kHz to 1 MHz) (effect on output voltage and common mode voltage)	0.05% f.s. or less (1000 V rms, DC to 100 Hz)			
	Linearity errors (typical)	± 2 ppm	-	± 2 ppm	-			
	Offset errors (typical)	± 5 ppm	-	± 5 ppm	-			
	Amplitude errors (typical)	(DC) ± 7 ppm, (10 to 500 Hz) $\pm 0.005\%$, (500 Hz-3 kHz) $\pm 0.01\%$, (3 k to 30 kHz) $\pm 0.1\%$, (30 k to 100 kHz) $\pm 0.4\%$, (100 k to 400 kHz) $\pm 1\%$, (400 kHz to 1 MHz) $\pm 3\%$	-	(DC) ± 7 ppm, (10 to 100 Hz) $\pm 0.005\%$, (100 Hz to 1 kHz) $\pm 0.01\%$, (1 k to 50 kHz) $\pm 0.1\%$, (50 k to 100 kHz) $\pm 0.3\%$, (100 k to 300 kHz) $\pm 1\%$, (300 kHz to 1 MHz) $\pm 3\%$	-			
	Frequency derating							
Output voltage	10 mV/A (= 2 V/200 A)	10 mV/A (= 2 V/200 A)	40 mV/A (= 2 V/50 A)	40 mV/A (= 2 V/50 A)				
Operating temperature and humidity*4	-40°C to 85°C (-40°F to 185°F), 80% RH or less	-30°C to 85°C (-22°F to 185°F), 80% RH or less	-40°C to 85°C (-40°F to 185°F), 80% RH or less	-30°C to 85°C (-22°F to 185°F), 80% RH or less				
Storage temperature and humidity*4	-40°C to 85°C (-40°F to 185°F), 80% RH or less	-30°C to 85°C (-22°F to 185°F), 80% RH or less	-40°C to 85°C (-40°F to 185°F), 80% RH or less	-30°C to 85°C (-22°F to 185°F), 80% RH or less				
Maximum rated voltage to earth	1000 V CATIII anticipated transient overvoltage: 8000 V	1000 V AC/DC CATIII (50/60 Hz) anticipated transient overvoltage: 8000 V	1000 V CATIII anticipated transient overvoltage: 8000 V	1000 V AC/DC CAT III (50/60 Hz) anticipated transient overvoltage: 8000 V				
Standards	Safety: EN 61010, EMC: EN 61326	Safety: EN 61010, EMC: EN 61326	Safety: EN 61010, EMC: EN 61326	Safety: EN 61010, EMC: EN 61326				
Cable length	CT6873: approx. 3 m (9.84 ft.) CT6873-01: approx. 10 m (32.81 ft.)	Approx. 3 m (9.84 ft.)	CT6872: approx. 3 m (9.84 ft.) CT6872-01: approx. 10 m (32.81 ft.)	Approx. 3 m (9.84 ft.)				
Dimensions	Approx. 70W x 110H x 53D mm (approx. 2.76W x 4.33H x 2.09D in.)	Approx. 70W x 100H x 53D mm (approx. 2.76W x 3.94H x 2.09D in.)	Approx. 70W x 110H x 53D mm (approx. 2.76W x 4.33 x 2.09D in.)	Approx. 70W x 100H x 53D mm (approx. 2.76W x 3.94H x 2.09D in.)				
Weight	CT6873: approx. 370 g (13.1 oz.) CT6873-01: approx. 690 g (24.3 oz.)	Approx. 350 g (12.3 oz.)	CT6872: approx. 370 g (13.1 oz.) CT6872-01: approx. 690 g (24.3 oz.)	Approx. 340 g (12.0 oz.)				

*1: \pm (% of reading + % of range) , range is PW8001 *2: \pm (% of reading + % of full scale) , full scale is rated current of sensor *3: Figures for CT6862-05 and CT6863-05 reflect effects of common-mode voltage. *4: Non-condensing

High-accuracy clamp current sensors

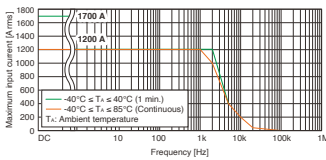
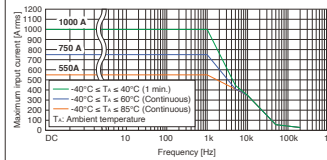
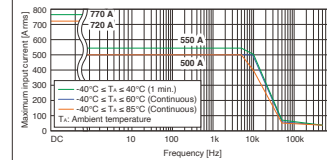
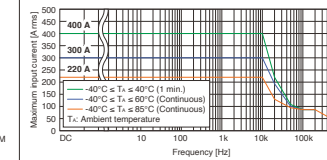
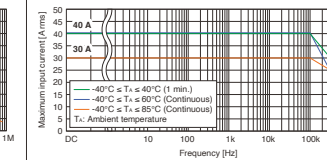

Product warranty period: 3 year Guaranteed accuracy period: 1 year

Model	CT6846A	CT6845A	CT6844A	CT6843A	CT6841A							
Appearance												
Rated current	1000 A AC/DC	500 A AC/DC	500 A AC/DC	200 A AC/DC	20 A AC/DC							
Frequency band	DC to 100 kHz	DC to 200 kHz	DC to 500 kHz	DC to 700 kHz	DC to 2 MHz							
Diameter of measurable conductors	Max. ϕ 50 mm (1.97 in.)	Max. ϕ 50 mm (1.97 in.)	Max. ϕ 20 mm (0.79 in.)	Max. ϕ 20 mm (0.79 in.)	Max. ϕ 20 mm (0.79 in.)							
Accuracy	U7001 Combined*1	Current (I)	DC	: $\pm 0.22\% \pm 0.07\%$	DC	: $\pm 0.22\% \pm 0.07\%$	DC	: $\pm 0.22\% \pm 0.07\%$	DC	: $\pm 0.22\% \pm 0.07\%$	DC	: $\pm 0.22\% \pm 0.1\%$
			45 Hz \leq f \leq 66 Hz	: $\pm 0.22\% \pm 0.06\%$	45 Hz \leq f \leq 66 Hz	: $\pm 0.22\% \pm 0.06\%$	45 Hz \leq f \leq 66 Hz	: $\pm 0.22\% \pm 0.06\%$	45 Hz \leq f \leq 66 Hz	: $\pm 0.22\% \pm 0.06\%$	45 Hz \leq f \leq 66 Hz	: $\pm 0.22\% \pm 0.06\%$
		Active power (P)	DC	: $\pm 0.22\% \pm 0.07\%$	DC	: $\pm 0.22\% \pm 0.07\%$	DC	: $\pm 0.22\% \pm 0.07\%$	DC	: $\pm 0.22\% \pm 0.07\%$	DC	: $\pm 0.22\% \pm 0.1\%$
			45 Hz \leq f \leq 66 Hz	: $\pm 0.22\% \pm 0.06\%$	45 Hz \leq f \leq 66 Hz	: $\pm 0.22\% \pm 0.06\%$	45 Hz \leq f \leq 66 Hz	: $\pm 0.22\% \pm 0.06\%$	45 Hz \leq f \leq 66 Hz	: $\pm 0.22\% \pm 0.06\%$	45 Hz \leq f \leq 66 Hz	: $\pm 0.22\% \pm 0.06\%$
	U7005 Combined*1	Current (I)	DC	: $\pm 0.22\% \pm 0.05\%$	DC	: $\pm 0.22\% \pm 0.05\%$	DC	: $\pm 0.22\% \pm 0.05\%$	DC	: $\pm 0.22\% \pm 0.05\%$	DC	: $\pm 0.22\% \pm 0.08\%$
			45 Hz \leq f \leq 66 Hz	: $\pm 0.21\% \pm 0.03\%$	45 Hz \leq f \leq 66 Hz	: $\pm 0.21\% \pm 0.03\%$	45 Hz \leq f \leq 66 Hz	: $\pm 0.21\% \pm 0.03\%$	45 Hz \leq f \leq 66 Hz	: $\pm 0.21\% \pm 0.03\%$	45 Hz \leq f \leq 66 Hz	: $\pm 0.21\% \pm 0.03\%$
		Active power (P)	DC	: $\pm 0.22\% \pm 0.05\%$	DC	: $\pm 0.22\% \pm 0.05\%$	DC	: $\pm 0.22\% \pm 0.05\%$	DC	: $\pm 0.22\% \pm 0.05\%$	DC	: $\pm 0.22\% \pm 0.08\%$
			45 Hz \leq f \leq 66 Hz	: $\pm 0.21\% \pm 0.03\%$	45 Hz \leq f \leq 66 Hz	: $\pm 0.21\% \pm 0.03\%$	45 Hz \leq f \leq 66 Hz	: $\pm 0.21\% \pm 0.03\%$	45 Hz \leq f \leq 66 Hz	: $\pm 0.21\% \pm 0.03\%$	45 Hz \leq f \leq 66 Hz	: $\pm 0.21\% \pm 0.03\%$
	Sensor only (amplitude)*2	DC	: $\pm 0.2\% \pm 0.02\%$	DC	: $\pm 0.2\% \pm 0.02\%$	DC	: $\pm 0.2\% \pm 0.02\%$	DC	: $\pm 0.2\% \pm 0.02\%$	DC	: $\pm 0.2\% \pm 0.05\%$	
		DC < f \leq 100 Hz	: $\pm 0.2\% \pm 0.01\%$	DC < f \leq 100 Hz	: $\pm 0.2\% \pm 0.01\%$	DC < f \leq 100 Hz	: $\pm 0.2\% \pm 0.01\%$	DC < f \leq 100 Hz	: $\pm 0.2\% \pm 0.01\%$	DC < f \leq 100 Hz	: $\pm 0.2\% \pm 0.01\%$	
		100 Hz < f \leq 500 Hz	: $\pm 0.5\% \pm 0.02\%$	100 Hz < f \leq 500 Hz	: $\pm 0.3\% \pm 0.02\%$	100 Hz < f \leq 500 Hz	: $\pm 0.3\% \pm 0.02\%$	100 Hz < f \leq 500 Hz	: $\pm 0.3\% \pm 0.02\%$	100 Hz < f \leq 500 Hz	: $\pm 0.3\% \pm 0.02\%$	
		500 Hz < f \leq 1 kHz	: $\pm 1.0\% \pm 0.02\%$	500 Hz < f \leq 1 kHz	: $\pm 0.5\% \pm 0.02\%$	500 Hz < f \leq 1 kHz	: $\pm 0.5\% \pm 0.02\%$	500 Hz < f \leq 1 kHz	: $\pm 0.5\% \pm 0.02\%$	500 Hz < f \leq 1 kHz	: $\pm 0.5\% \pm 0.02\%$	
		1 kHz < f \leq 5 kHz	: $\pm 2.0\% \pm 0.02\%$	1 kHz < f \leq 5 kHz	: $\pm 1.0\% \pm 0.02\%$	1 kHz < f \leq 5 kHz	: $\pm 1.0\% \pm 0.02\%$	1 kHz < f \leq 5 kHz	: $\pm 1.0\% \pm 0.02\%$	1 kHz < f \leq 5 kHz	: $\pm 1.0\% \pm 0.02\%$	
		5 kHz < f \leq 10 kHz	: $\pm 5.0\% \pm 0.02\%$	5 kHz < f \leq 10 kHz	: $\pm 1.5\% \pm 0.02\%$	5 kHz < f \leq 10 kHz	: $\pm 1.5\% \pm 0.02\%$	5 kHz < f \leq 10 kHz	: $\pm 1.5\% \pm 0.02\%$	5 kHz < f \leq 10 kHz	: $\pm 1.5\% \pm 0.02\%$	
10 kHz < f \leq 50 kHz		: $\pm 30\% \pm 0.02\%$	10 kHz < f \leq 20 kHz	: $\pm 5.0\% \pm 0.02\%$	10 kHz < f \leq 50 kHz	: $\pm 5.0\% \pm 0.02\%$	10 kHz < f \leq 50 kHz	: $\pm 5.0\% \pm 0.02\%$	10 kHz < f \leq 50 kHz	: $\pm 2.0\% \pm 0.02\%$		
-		-	20 kHz < f \leq 50 kHz	: $\pm 10\% \pm 0.05\%$	50 kHz < f \leq 100 kHz	: $\pm 15\% \pm 0.05\%$	50 kHz < f \leq 100 kHz	: $\pm 10\% \pm 0.05\%$	50 kHz < f \leq 100 kHz	: $\pm 5.0\% \pm 0.05\%$		
-		-	50 kHz < f \leq 100 kHz	: $\pm 30\% \pm 0.05\%$	100 kHz < f \leq 300 kHz	: $\pm 5\% \pm 0.05\%$	100 kHz < f \leq 300 kHz	: $\pm 5\% \pm 0.05\%$	100 kHz < f \leq 300 kHz	: $\pm 10\% \pm 0.05\%$		
-		-	-	-	300 kHz < f \leq 500 kHz	: $\pm 30\% \pm 0.05\%$	300 kHz < f \leq 500 kHz	: $\pm 15\% \pm 0.05\%$	300 kHz < f \leq 500 kHz	: $\pm 15\% \pm 0.05\%$		
-	-	-	-	500 kHz < f < 1 MHz	: $\pm 30\% \pm 0.05\%$	500 kHz < f < 1 MHz	: $\pm 30\% \pm 0.05\%$	500 kHz < f < 1 MHz	: $\pm 30\% \pm 0.05\%$			
Common-Mode Rejection Ratio (CMRR)	150 dB or greater (DC to 1 kHz) 130 dB or greater (1 kHz to 10 kHz) 100 dB or greater (10 kHz to 50 kHz) (effect on output voltage and common mode voltage)	150 dB or greater (DC to 1 kHz) 130 dB or greater (1 kHz to 10 kHz) 100 dB or greater (10 kHz to 100 kHz) (effect on output voltage and common mode voltage)	150 dB or greater (DC to 1 kHz) 135 dB or greater (1 kHz to 10 kHz) 120 dB or greater (10 kHz to 100 kHz) 100 dB or greater (100 kHz to 300 kHz) (effect on output voltage and common mode voltage)	150 dB or greater (DC to 1 kHz) 135 dB or greater (1 kHz to 10 kHz) 115 dB or greater (10 kHz to 100 kHz) 95 dB or greater (100 kHz to 500 kHz) (effect on output voltage and common mode voltage)	140 dB or greater (DC to 1 kHz) 125 dB or greater (1 kHz to 10 kHz) 100 dB or greater (10 kHz to 100 kHz) 80 dB or greater (100 kHz to 1 MHz) (effect on output voltage and common mode voltage)							
Linearity errors (typical)	± 20 ppm	± 20 ppm	± 20 ppm	± 20 ppm	± 20 ppm							
Frequency derating												
Output voltage	2 mV/A (= 2 V/1000 A)	4 mV/A (= 2 V/500 A)	4 mV/A (= 2 V/500 A)	10 mV/A (= 2 V/200 A)	100 mV/A (= 2 V/20 A)							
Operating temperature and humidity*3	-40°C to 85°C (-40°F to 185°F), 80% RH or less	-40°C to 85°C (-40°F to 185°F), 80% RH or less	-40°C to 85°C (-40°F to 185°F), 80% RH or less	-40°C to 85°C (-40°F to 185°F), 80% RH or less	-40°C to 85°C (-40°F to 185°F), 80% RH or less							
Storage temperature and humidity*3	-40°C to 85°C (-40°F to 185°F), 80% RH or less	-40°C to 85°C (-40°F to 185°F), 80% RH or less	-40°C to 85°C (-40°F to 185°F), 80% RH or less	-40°C to 85°C (-40°F to 185°F), 80% RH or less	-40°C to 85°C (-40°F to 185°F), 80% RH or less							
Withstand voltage	4260 V AC Withstand test current of 1 mA, 50/60 Hz, 1 min., between jaws and cable output terminal	4260 V AC Withstand test current of 1 mA, 50/60 Hz, 1 min., between jaws and cable output terminal	4260 V AC Withstand test current of 1 mA, 50/60 Hz, 1 min., between jaws and cable output terminal	4260 V AC Withstand test current of 1 mA, 50/60 Hz, 1 min., between jaws and cable output terminal	4260 V AC Withstand test current of 1 mA, 50/60 Hz, 1 min., between jaws and cable output terminal							
Standards	Safety: EN 61010, EMC: EN 61326	Safety: EN 61010, EMC: EN 61326	Safety: EN 61010, EMC: EN 61326	Safety: EN 61010, EMC: EN 61326	Safety: EN 61010, EMC: EN 61326							
Cable length	Approx. 3 m (9.84 ft.)	Approx. 3 m (9.84 ft.)	Approx. 3 m (9.84 ft.)	Approx. 3 m (9.84 ft.)	Approx. 3 m (9.84 ft.)							
Dimensions	Approx. 238W x 116H x 35D mm (approx. 9.37W x 4.57H x 1.38D in.)	Approx. 238W x 116H x 35D mm (approx. 9.37W x 4.57H x 1.38D in.)	Approx. 153W x 67H x 25D mm (approx. 6.02W x 2.64H x 0.98D in.)	Approx. 153W x 67H x 25D mm (approx. 6.02W x 2.64H x 0.98D in.)	Approx. 153W x 67H x 25D mm (approx. 6.02W x 2.64H x 0.98D in.)							
Mass	Approx. 990 g (34.9 oz.)	Approx. 860 g (30.3 oz.)	Approx. 400 g (14.1 oz.)	Approx. 380 g (13.4 oz.)	Approx. 370 g (13.1 oz.)							

*1: \pm (% of reading + % of range), range is PW8001 *2: \pm (% of reading + % of full scale), full scale is rated current of sensor *3: Non-condensing

High-accuracy clamp current sensors

Product warranty period: 3 year Guaranteed accuracy period: 1 year

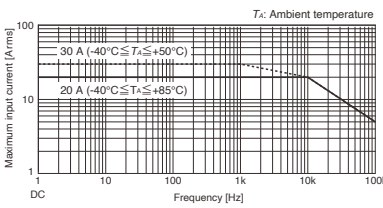
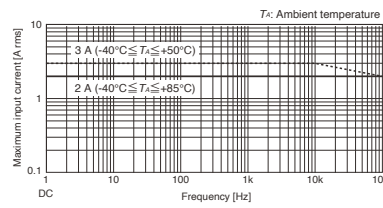
Model		CT6831	CT6830	
Appearance				
Rated current		20 A AC/DC	2 A AC/DC	
Frequency band		DC to 100 kHz	DC to 100 kHz	
Diameter of measurable conductors		Max. ϕ 5 mm (0.20 in.)	Max. ϕ 5 mm (0.20 in.)	
Accuracy	U7001 Combined	Current (I)	U7001 accuracy + Sensor accuracy	
		Active power (P)	U7001 accuracy + Sensor accuracy	
	U7005 Combined	Current (I)	U7005 accuracy + Sensor accuracy	
		Active power (P)	U7005 accuracy + Sensor accuracy	
	Sensor only (amplitude) ^{*1}	DC	: $\pm 0.3\% \pm 0.10\%$	DC
DC < f \leq 66 Hz		: $\pm 0.3\% \pm 0.01\%$	DC < f \leq 66 Hz	: $\pm 0.3\% \pm 0.05\%$
66 Hz < f \leq 500 Hz		: $\pm 0.3\% \pm 0.02\%$	66 Hz < f \leq 500 Hz	: $\pm 0.3\% \pm 0.05\%$
500 Hz < f \leq 1 kHz		: $\pm 0.5\% \pm 0.05\%$	500 Hz < f \leq 1 kHz	: $\pm 0.5\% \pm 0.05\%$
1 kHz < f \leq 5 kHz		: $\pm 1.0\% \pm 0.10\%$	1 kHz < f \leq 5 kHz	: $\pm 1.0\% \pm 0.10\%$
5 kHz < f \leq 10 kHz		: $\pm 5.0\% \pm 0.10\%$	5 kHz < f \leq 10 kHz	: $\pm 5.0\% \pm 0.10\%$
10 kHz < f \leq 100 kHz	: $\pm 30\% \pm 0.10\%$	10 kHz < f \leq 100 kHz	: $\pm 30\% \pm 0.10\%$	
Common-Mode Rejection Ratio (CMRR)		140 dB or greater (DC to 100 Hz) 130 dB or greater (100 Hz to 1 kHz) (effect on output voltage and common mode voltage)	140 dB or greater (DC to 100 Hz) 125 dB or greater (100 Hz to 1 kHz) (effect on output voltage and common mode voltage)	
Frequency derating				
Output voltage		0.1 V/A (= 2 V/20 A)	1 V/A	
Operating temperature and humidity ^{*2}		Sensor: -40°C to 85°C (-40°F to 185°F), 80% RH or less Multiplexer: -25°C to 50°C (-77°F to 122°F), 80% RH or less	Sensor: -40°C to 85°C (-40°F to 185°F), 80% RH or less Multiplexer: -25°C to 50°C (-77°F to 122°F), 80% RH or less	
Storage temperature and humidity ^{*2}		Sensor and multiplexer: -25°C to 50°C (-77°F to 122°F), 80% RH or less	Sensor and multiplexer: -25°C to 50°C (-77°F to 122°F), 80% RH or less	
Standards		Safety: EN 61010, EMC: EN 61326	Safety: EN 61010, EMC: EN 61326	
Cable length		Between sensor to multiplexer: approx. 4 m (13.12 ft.) Between multiplexer to output connector: approx 0.2 m (0.66 ft.)	Between sensor to multiplexer: approx. 4 m (13.12 ft.) Between multiplexer to output connector: approx 0.2 m (0.66 ft.)	
Dimensions		Sensor: Approx. 76.5W x 23.4H x 14.2D mm (approx. 3.00W x 0.92H x 0.56D in.) Multiplexer: Approx. 80W x 20H x 26.5D mm (approx. 3.15W x 0.79H x 1.04D in.)	Sensor: Approx. 76.5W x 23.4 H x 14.2D mm (approx. 3.00W x 0.92H x 0.56D in.) Multiplexer: Approx. 80W x 20H x 26.5D mm (approx. 3.15W x 0.79H x 1.04D in.)	
Mass		Approx. 160 g (5.64 oz.)	Approx. 160 g (5.64 oz.)	

*1: \pm (% of reading + % of full scale), full scale is rated current of sensor *2: Non-condensing

General use clamp sensor

Product warranty period: 3 year Guaranteed accuracy period: 1 year

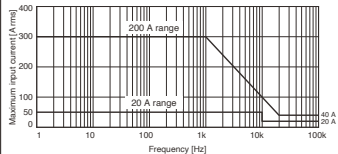
Model	9272-05
Appearance	
Rated current	20 AAC, 200 AAC (2 range)
Frequency band	1 Hz to 100 kHz
Diameter of measurable conductors	φ 46 mm or less
Accuracy (amplitude) ±(% of reading + % of full scale)	1 Hz ≤ f < 5 Hz : ±2.0% ±0.10%
	5 Hz ≤ f < 10 Hz : ±1.0% ±0.05%
	10 Hz ≤ f < 45 Hz : ±0.5% ±0.02%
	45 Hz ≤ f ≤ 66 Hz : ±0.3% ±0.01%
	66 Hz < f ≤ 500 Hz : ±0.5% ±0.02%
	500 Hz < f ≤ 1 kHz : ±0.5% ±0.02%
	1 kHz < f ≤ 5 kHz : ±1.0% ±0.05%
	5 kHz < f ≤ 10 kHz : ±2.5% ±0.10%
	10 kHz < f ≤ 20 kHz : ±5% ±0.1%
Frequency derating	
	20 A range: 100 mV/A (= 2 V/20 A)
	200 A range: 10 mV/A (= 2 V/200 A)
	Operating temperature and humidity*1
Storage temperature and humidity*1	-10°C to 60°C (14°F to 140°F), 80% RH or less
Withstand voltage	AC 600 V CATIII (50/60 Hz) anticipated transient overvoltage: 6000 V
Standards	Safety: EN 61010, EMC: EN 61326 Class A
Cable length	Approx. 3 m (9.84 ft.)
Dimensions*2	Approx. 78W × 188H × 35D mm (approx. 3.07W × 7.40H × 1.38D in.)
Weight	Approx. 450 g (15.9 oz.)

*1: Non-condensing *2: Excluding protruding parts and cables

Direct-wiring type high-accuracy current sensors

Product warranty period: 3 year Guaranteed accuracy period: 1 year

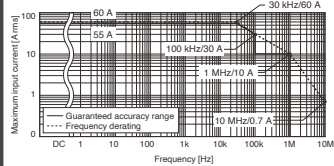
Model	PW9100A-3, PW9100A-4		
Appearance			
Rated current	50 A AC/DC		
Frequency band	DC to 3.5 MHz		
Measurement terminals	Isolated input, DCCT input Terminal block (with safety cover), M6 screws		
Accuracy	U7001 Combined*1	Current (I) Active power (P)	U7001 accuracy + Sensor accuracy
	U7005 Combined*1	Current (I)	DC : ±0.04% ±0.037%
		Active power (P)	45 Hz ≤ f ≤ 66 Hz : ±0.03% ±0.025%
	Sensor only (amplitude)*2	DC	±0.04% ±0.037%
		45 Hz ≤ f ≤ 66 Hz	±0.03% ±0.025%
		DC	±0.04% ±0.037%
		45 Hz ≤ f ≤ 66 Hz	±0.03% ±0.025%
		DC	±0.02% ±0.007%
		DC < f < 30 Hz	±0.1% ±0.02%
		30 Hz ≤ f < 45 Hz	±0.1% ±0.02%
45 Hz ≤ f ≤ 65 Hz		±0.02% ±0.005%	
65 Hz < f ≤ 500 Hz		±0.1% ±0.01%	
500 Hz < f ≤ 1 kHz		±0.1% ±0.01%	
1 kHz < f ≤ 5 kHz	±0.5% ±0.02%		
5 kHz < f ≤ 20 kHz	±1% ±0.02%		
20 kHz < f ≤ 50 kHz	±1% ±0.02%		
50 kHz < f ≤ 100 kHz	±2% ±0.05%		
100 kHz < f ≤ 300 kHz	±5% ±0.05%		
300 kHz < f ≤ 700 kHz	±5% ±0.05%		
700 kHz < f ≤ 1 MHz	±10% ±0.05%		
Effects of common mode voltage	120 dB or greater (50/60 Hz, 100 kHz) (effect on output voltage and common mode voltage)		
Frequency derating			
Output voltage	40 mV/A (= 2 V/50 A)		
Operating temperature and humidity*1	0°C to 40°C (32°F to 104°F), 80% RH or less		
Storage temperature and humidity*1	-10°C to 50°C (14°F to 122°F), 80% RH or less		
Withstand voltage	600 V CATIII, 1000 V CATII anticipated transient overvoltage: 6000 V		
Standards	Safety: EN 61010, EMC: EN 61326 Class A		
Cable length	Approx. 0.8 m (2.62 ft.)		
Dimensions	Approx. 430W × 88H × 260D mm (approx. 16.9W × 3.46H × 10.23D in.)		
Weight	PW9100A-3: approx. 3.7 kg (130.5 oz.) PW9100A-4: approx. 4.3 kg (151.7 oz.)		

*1: ±(% of reading + % of range), range is PW8001
*2: ±(% of reading + % of full scale), full scale is rated current of sensor
*3: Non-condensing

Measure Large Currents of up to 8000 A

The **Sensor Unit CT9557** adds and outputs current sensor output from multi-wire lines. With the PW8001, the CT9557 can be used to accurately measure large currents of up to 8000 A (on a 4-wire line).

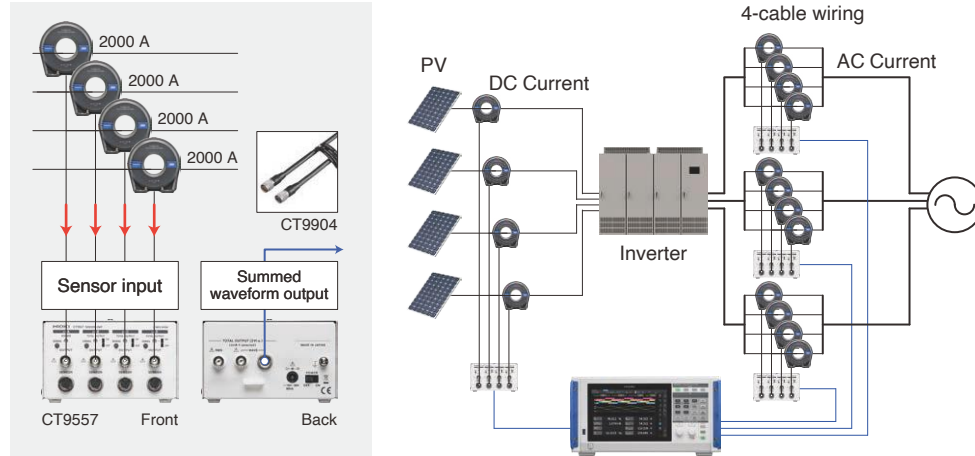

CT9557 specifications

Connectable current sensor	Current sensors are listed on p. 26 - p. 29
Summed waveform output accuracy ±(% of reading + % of full scale)	DC : ±0.06% ±0.03%
	to 1 kHz : ±0.06% ±0.03%
	to 10 kHz : ±0.10% ±0.03%
	to 100 kHz : ±0.20% ±0.10%
	to 300 kHz : ±1.0% ±0.20%
Operating temperature and humidity	-10°C to 50°C (14°F to 122°F), 80% RH or less
	Power supply
Output connector	HIOKI ME15W (male connector)
Dimensions (W x H x D)	Approx. 116 x 67 x 132 mm (approx. 4.57 x 2.64 x 5.20 in.)
Weight	Approx. 420 g (14.8 oz.)
Included accessories	AC ADAPTER Z1002, Power cord

Wiring	Current	Using sensors
Single-cable or bundled wiring	1000 A	CT6876A CT6846A
	2000 A	CT6877A
2-cable wiring	2000 A	CT9557 + CT6876A x 2/ CT9557 + CT6846A x 2
	4000 A	CT9557 + CT6877A x 2
3-cable wiring	3000 A	CT9557 + CT6876A x 3/ CT9557 + CT6846A x 3
	6000 A	CT9557 + CT6877A x 3
4-cable wiring	4000 A	CT9557 + CT6876A x 4/ CT9557 + CT6846A x 4
	8000 A	CT9557 + CT6877A x 4



Option
CONNECTION CABLE CT9904
Cable length: 1 m (3.28 ft)
CT9904 required to connect to PW8001.

SENSOR UNIT CT9557

Measure High Voltages of up to 5000 V

The **AC/DC High Voltage Divider VT1005** divides and outputs voltages of up to 5000 V. With the PW8001, the VT1005 can accurately measure high voltages of up to 5000 V.

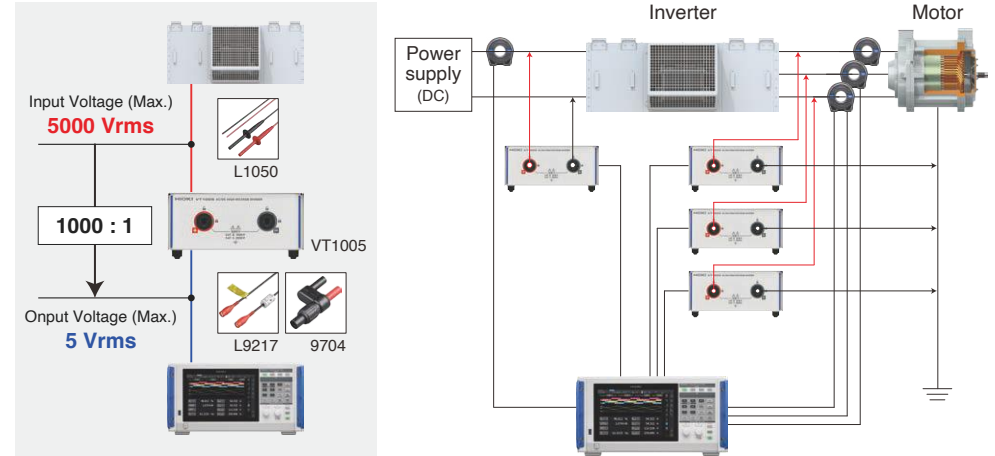

VT1005 specifications

Maximum rated voltage	5000 V rms, ±7100 V peak (Provided this falls within the frequency derating curve illustrated)
Maximum rated voltage (line-to-ground)	No measurement category: 5000 V AC/DC (7100 V peak, Anticipated transient overvoltage 0 V) Measurement category II: 2000 V AC/DC (Anticipated transient overvoltage 12000 V) Measurement category III: 1500 V AC/DC (Anticipated transient overvoltage 10000 V)
Measurement accuracy	±0.08% (DC), ±0.04% (50 Hz/60 Hz), ±0.17% (50 kHz)
Frequency flatness	Band where amplitude falls within ±0.1% range: 200 kHz (typical) Band where phase falls within ±0.1° range: 500 kHz (typical) ⁽⁵⁾
Measurement bandwidth	DC to 4 MHz (Amplitude and phase accuracy specified up to 1 MHz)
Voltage dividing ratio	1000 : 1
Common-mode voltage rejection ratio (CMRR)	50 Hz/60 Hz: 90 dB (typical), 100 kHz: 80 dB (typical)
Operating temperature and humidity range	-10°C to 50°C (14°F to 122°F), 80% RH or less (non-condensing)
Power supply	100 V to 240 V AC (50/60 Hz)
Dimensions (W x H x D)	Approx. 195.0 x 83.2 x 346.0 mm (approx. 7.68 x 3.28 x 13.62 in.)
Weight	Approx. 2.2 kg (77.6 oz.)
Measurement method	Differential input
Included accessories	- L1050-01 Voltage Cord (1.6 m/5.25 ft) - L9217 Connection Cord (insulated BNC, 1.6 m/ 5.25 ft) - 9704 Conversion Adapter (insulated-female BNC-to-banana plug) - Power cord



AC/DC HIGH VOLTAGE DIVIDER
VT1005

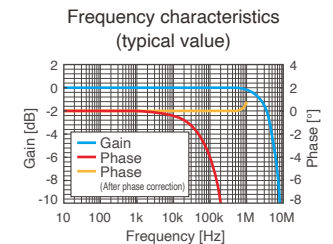
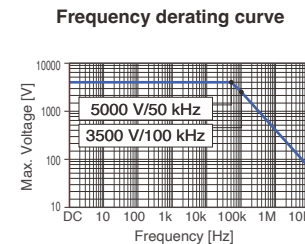



Accessories

- Power cord × 1
- Instruction manual × 1,
- GENNECT One (PC Applications) CD
- D-sub 25-pin connector × 1*

*PW8001-02, PW8001-05, PW8001-12, PW8001-15 only

- **Input units must be specified at the time of ordering**
- Input units, voltage cords, and current sensors are required for measurement.



Factory-installed units

U7001 2.5 MS/S INPUT UNIT

Order code: U7001

U7005 15 MS/s INPUT UNIT

Order code: U7005



Example configuration

PW8001-16

U7001 × 4

U7005 × 4

POWER ANALYZER PW8001

Model (order code)	Motor analysis	Waveform and D/A output	CAN or CAN FD interface	Optical link interface
PW8001-01	-	-	-	-
PW8001-02	-	Yes	-	-
PW8001-03	-	-	Yes	-
PW8001-04	-	-	-	Yes
PW8001-05	-	Yes	-	Yes
PW8001-06	-	-	Yes	Yes
PW8001-11	Yes	-	-	-
PW8001-12	Yes	Yes	-	-
PW8001-13	Yes	-	Yes	-
PW8001-14	Yes	-	-	Yes
PW8001-15	Yes	Yes	-	Yes
PW8001-16	Yes	-	Yes	Yes

Current measurement options

Model	Automatic phase correction	Rated current	Frequency range	No. of channels Cable length	
CT6877A	AC/DC CURRENT SENSOR	Yes	2000 A rms	DC to 1 MHz	3 m (9.84 ft.)
CT6877A-1	AC/DC CURRENT SENSOR	Yes	2000 A rms	DC to 1 MHz	10 m (32.81 ft.)
CT6876A	AC/DC CURRENT SENSOR	Yes	1000 A rms	DC to 1.5 MHz	3 m (9.84 ft.)
CT6876A-1	AC/DC CURRENT SENSOR	Yes	1000 A rms	DC to 1.2 MHz	10 m (32.81 ft.)
CT6904A-2*	AC/DC CURRENT SENSOR	Yes	800 A rms	DC to 4 MHz	3 m (9.84 ft.)
CT6904A-3*	AC/DC CURRENT SENSOR	Yes	800 A rms	DC to 2 MHz	10 m (32.81 ft.)
CT6904A	AC/DC CURRENT SENSOR	Yes	500 A rms	DC to 4 MHz	3 m (9.84 ft.)
CT6904A-1*	AC/DC CURRENT SENSOR	Yes	500 A rms	DC to 2 MHz	10 m (32.81 ft.)
CT6875A	AC/DC CURRENT SENSOR	Yes	500 A rms	DC to 2 MHz	3 m (9.84 ft.)
CT6875A-1	AC/DC CURRENT SENSOR	Yes	500 A rms	DC to 1.5 MHz	10 m (32.81 ft.)
CT6873	AC/DC CURRENT SENSOR	Yes	200 A rms	DC to 10 MHz	3 m (9.84 ft.)
CT6873-01	AC/DC CURRENT SENSOR	Yes	200 A rms	DC to 10 MHz	10 m (32.81 ft.)
CT6863-05	AC/DC CURRENT SENSOR	-	200 A rms	DC to 500 kHz	3 m (9.84 ft.)
CT6872	AC/DC CURRENT SENSOR	Yes	50 A rms	DC to 10 MHz	3 m (9.84 ft.)
CT6872-01	AC/DC CURRENT SENSOR	Yes	50 A rms	DC to 10 MHz	10 m (32.81 ft.)
CT6862-05	AC/DC CURRENT SENSOR	-	50 A rms	DC to 1 MHz	3 m (9.84 ft.)
CT6846A	AC/DC CURRENT PROBE	Yes	1000 A rms	DC to 100 kHz	3 m (9.84 ft.)
CT6845A	AC/DC CURRENT PROBE	Yes	500 A rms	DC to 200 kHz	3 m (9.84 ft.)
CT6844A	AC/DC CURRENT PROBE	Yes	500 A rms	DC to 500 kHz	3 m (9.84 ft.)
CT6843A	AC/DC CURRENT PROBE	Yes	200 A rms	DC to 700 kHz	3 m (9.84 ft.)
CT6841A	AC/DC CURRENT PROBE	Yes	20 A rms	DC to 2 MHz	3 m (9.84 ft.)
CT6831	AC/DC CURRENT PROBE	Yes	20 A rms	DC to 100 kHz	4.2 m (13.78 ft.)
CT6830	AC/DC CURRENT PROBE	Yes	2 A rms	DC to 100 kHz	4.2 m (13.78 ft.)
9272-05	CLAMP ON SENSOR	-	20 A rms, 200 A rms	1 Hz to 100 kHz	3 m (9.84 ft.)
PW9100A-3	AC/DC CURRENT BOX	Yes	50 A rms	DC to 3.5 MHz	3 channels
PW9100A-4	AC/DC CURRENT BOX	Yes	50 A rms	DC to 3.5 MHz	4 channels

*Build-to-order product

Voltage measurement options

1	L1025	VOLTAGE CORD	1500 V DC CATII, 1 A, 1000 V CATIII, 1 A banana-banana (red, black, 1 each), alligator clip, approx. 3 m (9.84 ft.) length
2	L9438-50	VOLTAGE CORD	1000 V CATIII, 10 A, 600 V CATIV, 10 A banana-banana (red, black, 1 each), alligator clip, spiral tube, approx. 3 m (9.84 ft.) length
3	L1000	VOLTAGE CORD	1000 V CATIII, 10 A, 600 V CATIV, 10 A banana-banana (red, yellow, blue, gray, 1 each, black x 4), alligator clip, approx. 3 m (9.84 ft.) length
4	L9257	CONNECTION CORD	1000 V CATIII, 10 A, 600 V CATIV, 10 A banana-banana (red, black, 1 each), alligator clip, approx. 1.2 m (3.94 ft.) length
5	L1021-01	PATCH CORD	1000 V CATIII, 10 A, 600 V CATIV, 10 A for branching voltage input, banana branch to banana clip (red x 1), 0.5 m (1.64 ft.) length
6	L1021-02	PATCH CORD	1000 V CATIII, 10 A, 600 V CATIV, 10 A for branching voltage input, banana branch to banana clip (black x 1), 0.5 m (1.64 ft.) length
7	L9243	GRABBER CLIP	1000 V CATIII, 1 A, (red, black, 1 each)
8	L4940	CONNECTION CORD	1000 V CATIII, 10 A, 600 V CATIV, 10 A banana-banana (red, black, 1 each), approx. 1.5 m (4.92 ft.) length
9	L4935	ALLIGATOR CLIP SET	1000 V CATIII, 10 A, 600 V CATIV, 10 A, (red, black, 1 each)
10	VT1005	AC/DC HIGH VOLTAGE DIVIDER	Voltage divider up to 5000 V and output to PW8001
11	L1050-01, -03	VOLTAGE CORD	For VT1005, 1.6 m (L1050-01), 3.0 m (L1050-03)

Connection options

12	L9217, -01, -02	CONNECTION CORD	600 V CATII, 0.2 A, 300 V CATIII, 0.2 A, For motor analysis input, For VT1005 connection, insulated BNC, L9217: 1.6 m (5.25 ft.), L9217-01: 3.0 m (9.84 ft.), L9217: 10 m (32.80 ft.)
13	9704	CONVERSION ADAPTER	For VT1005 connection, insulated BNC-banana
14	9642	LAN CABLE	CAT5e, cross-conversion connector, 5 m (16.40 ft.) length
15	9637	RS-232C CABLE	9pin-9pin, 1.8 m (5.91 ft.) length, cross cable
16	9151-02	GP-IB CONNECTOR CABLE	2 m (6.56 ft.) length
17	9444	CONNECTION CABLE	For external control, 9pin-9pin, straight cable, 1.5 m (4.92 ft.) length
18	L6000	OPTICAL CONNECTION CABLE	50 μm, 125 μm multi-mode fiber equivalent, 10 m (32.81 ft.) length
19	9165	CONNECTION CABLE	For BNC synchronization, metal BNC by metal BNC, 1.5 m (4.92 ft.) length
20	9713-01	CAN CABLE	One end terminating in bare wires, 2 m (6.56 ft.) length
21	CT9902	EXTENSION CABLE	For extension of current sensor cable, ME15W-ME15W, 5 m (16.40 ft.) length
22	CT9900	CONVERSION CABLE	Required in order to connect current sensors with Hioki PL23 output connector to the PW8001.
23	CT9557	SENSOR UNIT	Adds output waveforms from up to 4 current sensors to 1 channel and outputs it to the PW8001.
24	CT9904	CONNECTION CABLE	Cable length 1 m; required in order to connect the CT9557's added waveform output terminal to the PW8001.

Build-to-order options

25	L3000	D/A OUTPUT CABLE	D-sub 25-pin by BNC (male) 20-channel conversion cable
26	Z5200	BNC TERMINAL BOX	D-sub 25-pin by BNC (female) 20-channel conversion box
27	C8001	CARRYING CASE	Hard trunk type, with casters
28	Z5300	RACKMOUNT FITTINGS	For EIA standard rack
29	Z5301	RACKMOUNT FITTINGS	For JIS standard rack

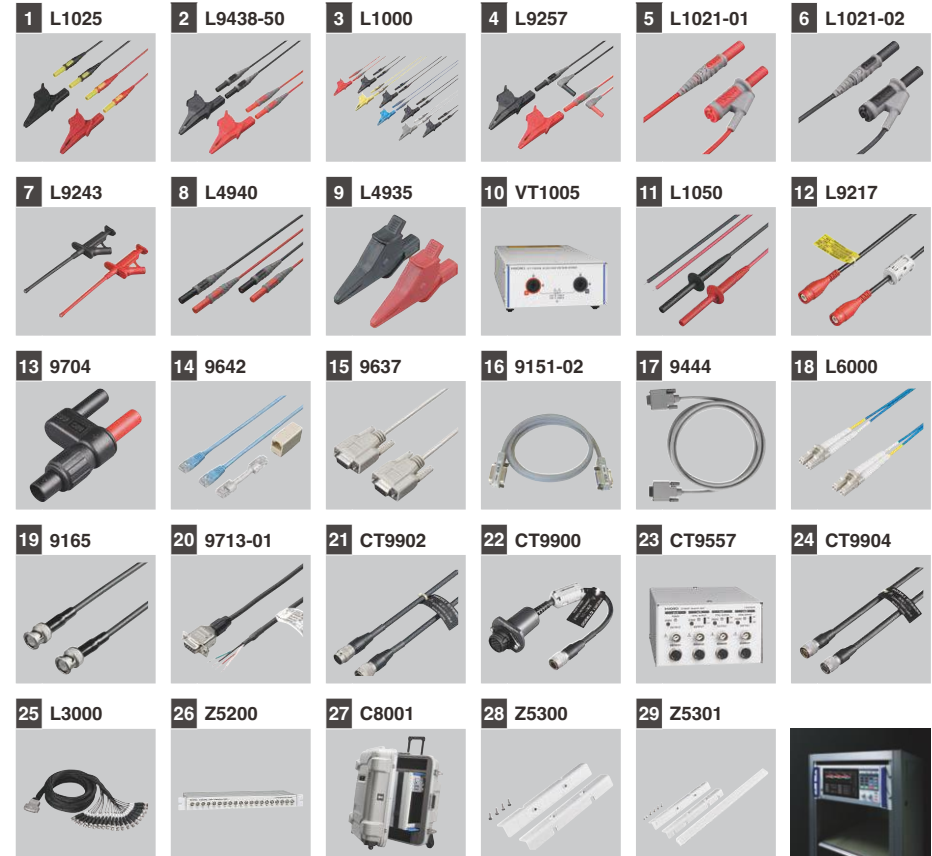

Rack-mounted PW8001 (Z5300, Z5301) Pictured: Z5300

Note: Company names and product names appearing in this brochure are trademarks or registered trademarks of various companies.

HIOKI

HIOKI E. E. CORPORATION

HEADQUARTERS

81 Koizumi,
Ueda, Nagano 386-1192 Japan
<https://www.hioki.com/>



Scan for all
regional contact
information

DISTRIBUTED BY